

Owner's Manual

Nº502
Media Console

mark
levinson®

FCC Notice

This equipment has been tested and found to comply with the limits for a Class B digital device, pursuant to Part 15 of the FCC Rules. These limits are designed to provide reasonable protection against harmful interference in a residential installation. This equipment generates, uses and can radiate radio frequency energy and, if not installed and used in accordance with the instructions, may cause harmful interference to radio communications. However, there is no guarantee that interference will not occur in a particular installation. If this equipment does cause harmful interference to radio or television reception, which can be determined by turning the equipment off and on, the user is encouraged to try to correct the interference by one or more of the following measures:

- Reorient or relocate the receiving antenna.
- Increase the separation between the equipment and the receiver.
- Connect the equipment into an outlet on a circuit different from that to which the receiver is connected.
- Consult the dealer or an experienced radio/TV technician for help.

Caution!

Changes or modifications not expressly approved by the party responsible for compliance could void the user's authority to operate the equipment.

Canada

This Class B digital apparatus complies with Canadian ICES-003.

Cet appareil numérique de la Classe B est conforme à la norme NMB-003 du Canada.



For customer service and product shipment information, refer to the website: www.marklevinson.com

Mark Levinson and Logic 7 are registered trademarks of Harman International Industries.

HDCP and High-bandwidth Digital Content Protection are trademarks of Intel LLC.

Manufactured under license from Dolby Laboratories. "Dolby", "Pro Logic", "Surround EX" and the double-D symbol are trademarks of Dolby Laboratories.

DTS, DTS-ES and Neo:6 are trademarks or registered trademarks of DTS, Inc.

HDMI and High-Definition Multimedia Interface are trademarks or registered trademarks of HDMI Licensing LLC.

Microsoft and Windows are registered trademarks of Microsoft Corporation in the United States and/or other countries.

Other company and product names may be trademarks of the respective companies with which they are associated.

©2008 Harman International Industries, Incorporated. All rights reserved.

This document should not be construed as a commitment on the part of Harman International Industries, Incorporated. The information it contains is subject to change without notice. Harman International Industries, Incorporated assumes no responsibility for errors that may appear within this document.

Important Safety Instructions

1. Read these instructions.
2. Keep these instructions.
3. Heed all warnings.
4. Follow all instructions.
5. Do not use this apparatus near water.
6. Clean only with a dry cloth.
7. Do not block any ventilation openings. Install in accordance with the manufacturer's instructions.
8. Do not install near any heat sources such as radiators, heat registers, stoves or other apparatus that produce heat.
9. Do not defeat the safety purpose of the polarized or grounding-type plug. A polarized plug has two blades with one wider than the other. A grounding-type plug has two blades and a third grounding prong. The wide blade or third prong is provided for your safety. If the provided plug does not fit into your outlet, consult an electrician for replacement of the obsolete outlet.
10. Protect the power cord from being walked on or pinched, particularly at plugs, convenience receptacles and the point where it exits from the apparatus.
11. Only use attachments and accessories specified by the manufacturer.



12. Use only with the cart, stand, tripod, bracket or table specified by the manufacturer or sold with the apparatus. When a cart is used, use caution when moving the cart/apparatus combination to avoid injury or tip over.
13. Unplug this apparatus during lightning storms or when unused for long periods of time.
14. Refer all servicing to qualified service personnel. Servicing is required when the apparatus has been damaged in any way, such as when the power-supply cord or plug is damaged; liquid has been spilled or objects have fallen into the apparatus; or the apparatus has been exposed to rain or moisture, does not operate normally or has been dropped.
15. The MAINS cord is intended to be the safety disconnect device for this apparatus and shall remain readily operable at all times.
16. Ventilation should not be impeded by covering the ventilation openings with items such as newspapers, table cloths, curtains and so on.
17. No naked flame sources, such as candles, should be placed on the apparatus.
18. Terminals marked with this symbol may be considered HAZARDOUS LIVE, and the external wiring connected to these terminals requires installation by an INSTRUCTED PERSON or the use of ready-made leads or cords.
19. This product must be terminated with a three-conductor AC mains power cord that includes an earth ground connection. To prevent shock hazard, all three connections must ALWAYS be used.

Warning!

To reduce the risk of fire or electric shock, do not expose this apparatus to rain or moisture. The apparatus shall not be exposed to dripping or splashing. No objects filled with liquids, such as vases, shall be placed on the apparatus.

Safety Terms & Symbols

Terms in This Manual

These terms may appear in this manual:

Warning!

Calls attention to a procedure, practice, condition or the like that, if not correctly performed or adhered to, could result in personal injury or death.

Caution!

Calls attention to a procedure, practice, condition or the like that, if not correctly performed or adhered to, could result in damage or destruction to part or all of the component.

Note

Calls attention to information that is essential to highlight.

Symbols on the Product

These symbols may appear on the product:



Appears on the component to indicate the presence of noninsulated, dangerous voltage inside the enclosure – voltage that may be sufficient to constitute a risk of shock.



Appears on the component to indicate important operation and maintenance instructions included in the accompanying documentation.



Appears on the component to indicate compliance with the EMC (Electromagnetic Compatibility) and LVD (Low-Voltage Directive) standards of the European community.

Documentation Conventions

This document contains general safety and operation instructions for the Nº502 Media Console. It is important to read this document before attempting to use this product. Please pay particular attention to safety instructions.

This manual is not intended as a general reference guide for home theater systems. If you're uncertain how to set up or maintain your system, seek the advice of a professional installer or ask your dealer for a recommendation.

All product graphics are included for reference only and may not completely reflect the physical product that is shipped.

How This Manual is Organized

This manual is divided into five sections:

- **Getting Started** provides an overview of the Nº502 Media Console and includes installation and power considerations, product information, unpacking instructions, and a first-time operation procedure.
- **Basic Operation** explains the basic functions of the front and rear panels, remote control, and menu system.
- **Customizing the Nº502** describes how to set up the Nº502 Media Console and includes information on advanced user features such as trigger outputs, ML Net, and downloading the configuration.
- **Troubleshooting & Maintenance** provides information for troubleshooting and descriptions of error messages, as well as maintenance instructions for proper care of the Nº502 Media Console.
- The **Appendix** provides the specifications, Declaration of Conformity, menu trees and other useful information.

v

Conventions

This manual uses the following conventions:

- The names of buttons, knobs, and connectors on the product are represented in the same manner in the manual. For instance, if a button is labeled as “FP DISPLAY” on the front panel of the product, then the manual refers to that button as “FP DISPLAY”.
- Menu names are derived from their associated buttons – i.e., the Setup button opens the Setup menu. Any submenus associated with the main menu follow the same rule.

Table of Contents

Section 1: Getting Started

About the Nº502 Media Console	1-1
Installation Considerations	1-3
Power Requirements	1-4
First-Time Operation	1-5
Replacing the Remote Control Batteries	1-6

Section 2: Basic Operation

Front Panel Overview	2-1
Rear Panel Overview	2-4
Remote Control Overview	2-8
Remote Control Versus Front Panel	2-11
Menu System Overview	2-12
Status Panels	2-15

Section 3: Customizing the Nº502

Add New, Name, & Delete	3-1
Setup Step 1: Displays	3-3
Display Setup	3-4
Setup Step 2: Speakers	3-7
Speaker Setup	3-8
Video Profiles	3-25
Audio Profiles	3-28
Activities	3-32
User Options	3-35
Triggers	3-41
Internal Web Pages	3-43
ML Net	3-43
Using Surround Modes	3-47
Surround Mode Descriptions	3-48
Surround Mode Parameter Descriptions	3-55
Name Selector	3-59

Section 4: Troubleshooting & Maintenance

Automatic Calibration Errors	4-6
Error Messages	4-8
Troubleshooting Display Formats	4-11
Restoring Factory Default Settings	4-14
Care & Maintenance	4-15

Appendix

Specifications	A-1
Nº502 Media Console Dimensions	A-4
Declaration of Conformity	A-5
Rack Mount Kit Instructions	A-6
Activity Menu & Zone Menu Trees	A-7
Display Setup & Video Profile Setup Menu Trees	A-8
Speaker Setup Menu Tree	A-9
Audio Profile Setup & Activity Setup Menu Trees	A-10
User Options Setup Menu Tree	A-11
Understanding Room Correction	A-12
Surround Sound Issues	A-17
Link2	A-19
Saving the Nº502 Configuration	A-20

Index

1

Getting Started

About the N°502 Media Console

Thank you for purchasing the N°502 Media Console. True to the Mark Levinson® tradition of home theater excellence, the superb sound and broadcast-quality video processing capabilities of the N°502 Media Console are unsurpassed in today's marketplace.

Product Description

The N°502 Media Console features an intuitive interface with user-configurable Activity list, separate audio and video profiles, and independent speaker configurations. Profiles and Setups can be configured and then assigned to multiple Activities, making setup time shorter while providing maximum flexibility. With a wide range of available audio and video input formats, multiple Activities can be assigned to efficiently manage a wide range of media sources. The fully automated calibration performs speaker distances and levels calibration as well as Room Correction, which neutralizes room modes, making all audio sources sound more accurate and true to the original recording.

1-1

The large full-color front panel display, capable of producing elegant bit-accurate graphics, allows access to the N°502's menu system and can also be used in Preview mode. Preview mode enables other video inputs to be viewed without disturbing the current activity, providing an effective means to monitor multiple inputs without disturbing the active video source.

The N°502 features an extensive list of surround modes, including Logic 7, Dolby, and DTS modes. To retain the purity of the audio, the N°502 has separate analog output cards for each channel and all input/output connectors are isolated from the chassis to prevent noise pickup from common impedance coupling. In addition, the volume controls have been redesigned for improved noise performance at lower volume settings while still preserving the full digital depth of the audio.

The N°502 contains state-of-the-art, broadcast-quality video processing capability, enabling true-to-life colors, exceptional detail, and deep blacks. In addition, the N°502 uses specially-designed motion adaptive video de-interlacing with edge interpolation for both high-definition and standard definition video sources. Advanced noise reduction and detail enhancement circuitry cleans up and sharpens images degraded by compression or analog circuitry from such sources as standard DVDs and satellite or cable broadcasts.

For external controls, the N°502 introduces ML Net protocol, which controls and synchronizes other Mark Levinson products through the use of an Ethernet port. RS-232, programmable triggers, and Mark Levinson Link2 functions are also supported.

The N°502 Media Console is Mark Levinson's finest processor to date. The processing power and superb performance will simply astound you, as will its simplicity and versatility, proving that this product is the latest in a line of products that represent the very best.

What's in the Box

The following is included with your N°502 Media Console:

Item	Quantity
N°502 Media Console	1
N°502 remote control	1
Phillips-head screwdriver	1
N°502 owner's manual (this document)	1
AAA alkaline batteries (for remote control)	2
White gloves	1 pair
RCA-BNC connectors	3
Detachable AC power cord* <i>*Not included in shipments to Japan</i>	1

1-2

Available Options

The following optional accessories are available for purchase:

- 4-Microphone Kit - provides four microphones for use with the automatic calibration.
- Rack Mount Kit - provides the mounting hardware necessary to install the N°502 into an equipment rack.

Contact an authorized Mark Levinson dealer for availability and pricing. Authorized dealers may also have information on additional options.

Product Registration

Register your N°502 online at www.marklevinson.com within 15 days of purchase. Retain the original, dated sales receipt as proof of warranty coverage.

Installation Considerations

The N°502 Media Console requires special care during installation to ensure optimal performance. Pay particular attention to instructions included in this section and to precautions included throughout this owner's manual.

Unpacking **DO** save all packing materials for possible future shipping needs.

DO inspect the N°502 for signs of damage during shipment. If damage is discovered, contact your authorized Mark Levinson dealer for assistance in making appropriate claims.

DO locate and remove the accessory box from the carton. Make sure it contains all of the items listed in the "What's in the Box" table on the previous page. If not, contact your authorized Mark Levinson dealer.

Placement and Ventilation

DO install the N°502 Media Console on its own shelf for proper ventilation.

DO install the N°502 chassis on a solid, flat, level surface.

1-3

DO install the N°502 Media Console close to associated components to keep interconnecting cables as short as possible.

DO select a dry, well-ventilated location out of direct sunlight.

DO allow at least 3 to 4 inches (8 to 10cm) of clearance above the Media Console for proper heat dissipation.

DO NOT place the N°502 on a thick rug or carpet or cover the N°502 Media Console with a cloth, as this might prevent proper cooling.

DO NOT expose the N°502 Media Console to high temperatures, humidity, steam, smoke, dampness, or excessive dust. Avoid installing the processor near radiators and other heat-producing appliances.

DO NOT install the N°502 near unshielded TV or FM antennas, cable TV decoders, or other RF-emitting devices that might cause interference.

DO NOT place the N°502 on a windowsill or in any location where it will be exposed to direct sunlight.

DO NOT obstruct the IR (infrared) receiver/transmitter located on the front panel display. The remote control must be in line-of-sight with the front panel IR receiver. If strong sunlight or fluorescent light shines on the IR receiver, remote control may be unreliable.

Warning!

MAKE SURE all components are properly grounded. Do not defeat the safety purpose of polarized or grounding-type plugs with “ground-lifter” or “cheater” adapters. Doing so may cause dangerous voltage to build up between components, which may result in personal injuries and/or product damage.

Power Requirements

At the factory, the N°502 Media Console is configured for 100, 120, 220, or 230-240 VAC power operation at 50Hz or 60Hz. Before operating the N°502, ensure that the power label on the rear panel near the AC input connector indicates the correct operating voltage.

Caution!

DO NOT attempt to adjust the operating voltage. Consult a Mark Levinson dealer if the operating voltage is incorrect or must be changed for relocation purposes.

Different operating voltages may require the use of different power cords and/or attachment plugs. Contact a Mark Levinson dealer for additional assistance.

1-4

Operating States

The N°502 Media Console is designed for continuous operation and has three operating states:

- **Off** – the AC mains power is disconnected using the front panel Power switch or by removing the power cord from the rear panel.
- **Standby** – the N°502 is powered up, but the audio outputs are muted and the video outputs are off.
- **On** – everything is powered up and all configured outputs are active.

Caution!

BEFORE moving the N°502 Media Console, make sure it is powered off with the power button. Then make sure the power cord is disconnected from the rear panel connector and the electrical outlet.

First-Time Operation

Perform the following steps to unpack and power up the new N°502 Media Console.

Unpacking

1. Position the box so that the top side is facing up.
2. Use a utility knife to slice open the box and lift the box sides apart to reveal the inner box.
3. Carefully slice open the inner box and lift the box sides apart.
4. Remove the white accessory box and put it aside.
5. Remove the foam insert from the top of the N°502 Media Console.
6. Carefully lift the N°502 out of the box.
7. Remove the antistatic bag from the N°502.

Initial Power-Up

1. Connect all system speakers and amplifiers to the Audio Output connectors on the rear panel of the N°502.
2. Using an HDMI cable, connect a DVD player output to the HDMI-1 input on the rear panel of the N°502.
3. Using a second HDMI cable, connect the HDMI-1 output on the N°502 to the display input.
4. Plug the power cord into the rear panel AC Input connector of the N°502 and then connect to your wall outlet. Make sure that the power rating listed on the rear panel of the N°502 is less than the power available at the wall outlet.
5. Press the Power button on the front panel. When the N°502 completes its power-up cycle, it automatically enters Standby mode. When the LED above the Standby button begins to slowly blink, the N°502 is ready.
6. Press the Standby button to take the N°502 out of Standby mode.

1-5

Note

If the front panel display is not bright enough or is too bright, multiple presses of the front panel Display Intensity button scrolls through the different brightness levels.

7. Press the Activity button on the remote control. Verify that the TV Activity is in red test, indicating that TV is the currently selected Activity.
8. Put a disc in the DVD player and press the Play button. Once the disc loads, the DVD media should be visible on the front panel display. Also confirm that the audio track can be heard through the front left and right speakers.

Now that the N°502 Media Console is unpacked and initial power-up confirmed, it's time to set up and calibrate the system. The rest of the manual is designed to help with these steps.

- **Chapter 2: Basic Operation** reviews the basic functions of the front and rear panels, remote control, and menu system.
- **Chapter 3: Customizing the N°502** explains how to set up the N°502 and discusses advanced user functions such as trigger outputs, ML Net, and the configuration download utility.
- **Chapter 4: Troubleshooting and Maintenance** provides a troubleshooting guide and error message descriptions, as well as maintenance instructions.
- The **Appendix** provides N°502 specifications, menu trees, rack-mount instructions, and other useful information.

1-6

Replacing the Remote Control Batteries

The N°502 Media Console remote control has two installed AAA batteries. These should be replaced as required. We recommend using alkaline batteries, which are long lasting and do not leak.

To replace the remote control batteries:

1. Locate the battery compartment cover on the bottom of the remote control.
2. Using a Phillips-head screwdriver, remove the three screws from the battery compartment cover and set them aside.
3. Remove the battery compartment cover.
4. Remove old batteries.
5. Observing the proper polarity, insert the new batteries.
6. Position the cover over the battery compartment and replace the screws removed in Step 2.
7. Properly dispose of the old batteries.

2

Basic Operation

Front Panel Overview

The numbers in the front panel illustration correspond with the summary list of items below.



2-1

- | | | |
|-----------------------------|-------------------------|-------------------------|
| 1. Zone button | 6. Mute button | 11. Activity knob |
| 2. Preview button | 7. Video Profile button | 12. Standby button |
| 3. Display Intensity button | 8. Audio Profile button | 13. Power button |
| 4. Setup button | 9. Surround button | 14. Front Panel Display |
| 5. Menu button | 10. Enter button | 15. Volume knob |

1. Zone button

Switches the N°502 controls between the Main Zone and Remote Zone. When the Zone LED is lit, only the Remote Zone controls are active. Controls that are Main Zone specific (for instance, the Video Profile menu) are not accessible while the Zone LED is lit.

2. Preview button

Allows the preview of video sources that are not part of the current Activity. Preview mode is only active when the front panel LED located to the left of the Preview button is illuminated.

3. Display Intensity button

Controls the brightness intensity level of the front panel display and all LEDs on the front panel. Multiple presses of the Display Intensity button cycle through the available brightness levels – High, Medium, Low, and Off.

The Display Intensity button also provides access to the alternative video output monitor. Refer to the “Monitor Out” description in the “Rear Panel Overview” section found later in this chapter for more details.

4. Setup button

Accesses the Setup menu to configure all system functions, advanced user options, and connectivity of the N°502 Media Console. In addition, pressing the Setup button from within any menu closes the menu structure. To set up the N°502, refer to *Chapter 3: Customizing the N°502*.

5. Menu button

Accesses the Main Zone Audio menu to make real-time adjustments to various audio features of the N°502. In addition, when the Menu button is pressed from within any menu, the navigation returns to the previous menu level.

6. Mute button

Reduces the volume of the audio output within the Main Zone or Remote Zone. When the Mute function is active, the front panel Mute LED is lit. To deactivate the Mute control, simply adjust the volume or press the Mute button until the front panel Mute LED is NOT lit. The actual volume-level change of the Mute function can be modified in the Setup menu.

7. Video Profile button

Accesses the list of available Video Profiles. Multiple presses of the Video Profile button scrolls through the list; pressing the Enter button loads the new selection. The loaded Video Profile displays in red text.

8. Audio Profile button

Accesses the list of available Audio Profiles. Multiple presses of the Audio Profile button scrolls through the list; pressing the Enter button loads the new selection. The loaded Audio Profile displays in red text.

9. Surround button

Accesses the list of available surround modes. Multiple presses of the Surround button scrolls through the list; pressing the Enter button loads the new selection. The loaded surround mode displays in red text.

10. Enter button

Has two functions in the menu system:

- to advance through the menus.
- to save a modified parameter value.

11. Activity knob

The Activity knob has two functions:

- accesses the list of available Activities. Turning the knob scrolls through the list; pressing the Enter button loads the new selection. The loaded Activity displays in red text.
- performs the same function as the ▲ and ▼ buttons on the remote control from within any menu structure.
- Navigates through the Activity list while in Preview mode.

12. Standby button

Activates and deactivates the N°502's Standby mode. The Standby LED located directly above the Standby button is illuminated when the N°502 is operational, and blinks slowly when the N°502 is in Standby mode.

13. Power button

Controls the AC input to the N°502 when the supplied power cord is connected between the rear panel power connector and an electrical outlet.

- When the N°502 is off, pressing the Power button supplies AC power, putting the N°502 into Standby mode.
- When the N°502 is powered on or is in Standby mode, pressing the Power button disconnects the AC power, turning off the N°502.

Caution!

Before operating the N°502, verify that the voltage label near the AC input connector indicates an operating voltage compatible with the voltage level of the electrical outlet you intend to use.

2-3

14. Front Panel Display

The full-color front panel display can:

- access the menu system without having to turn on the main video display.
- monitor the Main Zone when the main display is out of sight.
- view a different video source without disturbing the main display.
- verify Remote Zone status.

15. Volume knob

Turning the Volume knob adjusts the volume level. The volume range for the Main Zone is 0 to 100 in 0.1 increments. The volume range for the Remote Zone is 0 to 100 in 0.5 increments.

The volume control for the Main and Remote Zones are independent of each other; adjusting the Volume knob only changes the volume in the currently active Zone. For example, adjusting the Remote Zone Volume does not affect the Main Zone Volume.

When adjusting the volume, you may notice an REF tag positioned on the adjustment bar. REF indicates the Reference Volume level.

Rear Panel Overview

The numbers in the rear panel illustration correspond with the summary list of items below.

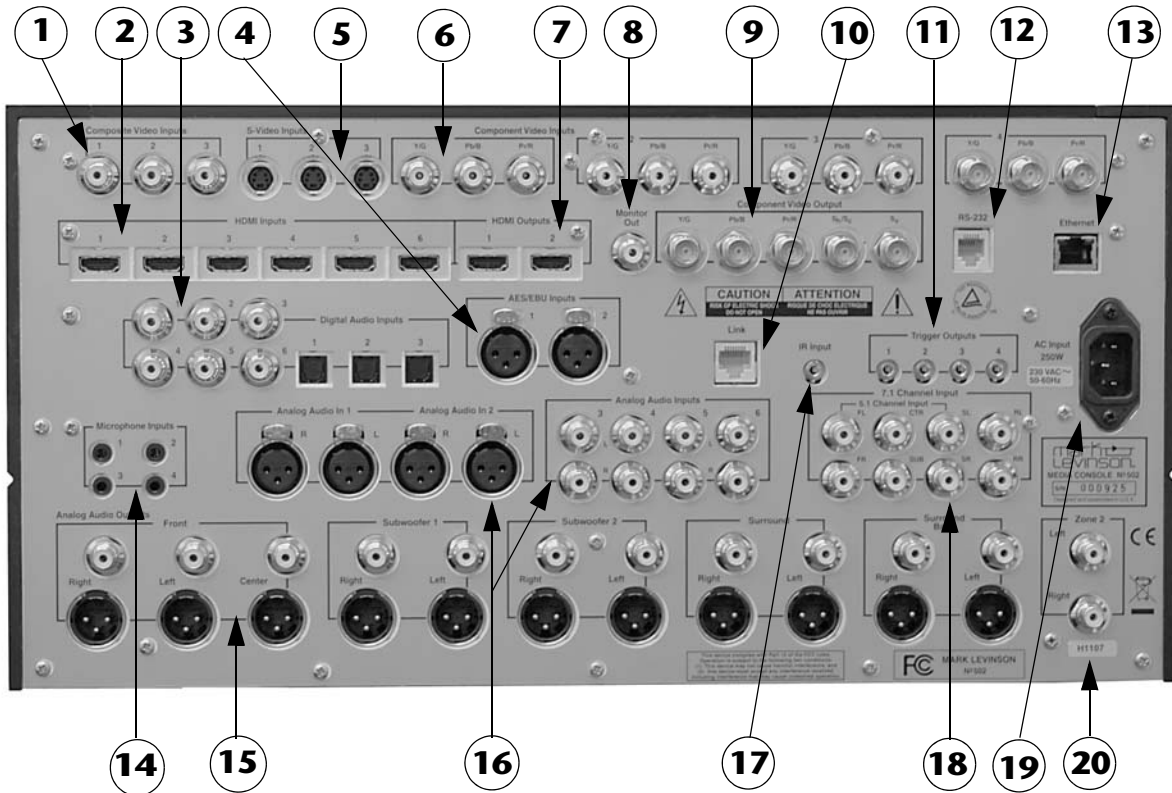

2-4

- | | | |
|---------------------------|---------------------------|---|
| 1. Composite Video Inputs | 8. Monitor Out | 15. Analog Audio Outputs |
| 2. HDMI Inputs | 9. Component Video Output | 16. Analog Audio Inputs |
| 3. Digital Audio Inputs | 10. Link2 port | 17. IR Input |
| 4. AES/EBU Inputs | 11. Trigger Outputs | 18. 7.1-Channel/
5.1-Channel Analog
Audio Input |
| 5. S-Video Inputs | 12. RS-232 Control port | 19. AC Input |
| 6. Component Video Inputs | 13. Ethernet port | 20. Remote Zone Analog
Audio Outputs |
| 7. HDMI Outputs | 14. Microphone Inputs | |

1. Composite Video Inputs

Accept composite analog video inputs. There are three composite video connectors labeled 1 to 3.

2. HDMI Inputs

Accept High-Definition Multimedia Interface™ (HDMI) inputs. There are six HDMI input connectors labeled 1 to 6.

- 3. Digital Audio Inputs** Accept S/PDIF digital audio inputs using six coaxial RCA connectors, labeled 1 to 6, and three Toslink optical connectors, labeled 1 to 3.
- 4. AES/EBU Inputs** Accept two AES/EBU XLR inputs, labeled 1 and 2, for carrying digital audio signals.
- 5. S-Video Inputs** Accept S-video inputs. There are three S-video input connectors labeled 1 to 3.
- 6. Component Video Inputs** Accept component video inputs through four Y-Pb-Pr connector sets, labeled 1 to 4.
- 7. HDMI Outputs** Provide HDMI outputs for HDMI-equipped displays through two connectors labeled 1 and 2.
-
- Note** Only one video output connector, either the Component, HDMI-1, or HDMI-2 connector, can be active at any given time.
-
- 8. Monitor Out** Provides an output for an alternative video monitor. The default setting for the Monitor Out(put) is Off. 2-5
-
- Note** The front panel display and Monitor Out share the same video signal. Therefore, when the Monitor Out connector is turned on, the front panel display is deactivated.
-
- The monitor output can only be turned on by a key press command on the N°502 front panel.
- To activate the Monitor Out connector, press and hold the Display Intensity button until the front panel display turns off. The Monitor Out connector is now active.
- To turn off the Monitor Out connector and reactivate the front panel display, press and hold the Display Intensity button until the front panel display turns on again.
- 9. Component Video Output** Provides a component video output using BNC connectors.
-
- Note** If HDCP (High-Bandwidth Digital Content Protection) is active, then the component video output is disabled. To verify this condition, open the Detailed Status Panel for the Activity. The Detailed Status Panel identifies the presence of HDCP source material. Refer to the "Status Panels" section at the end of this chapter for further information.
-

10. Link2 port Uses the Link2 protocol to link two or more Mark Levinson components. For more information on the Link2 protocol and how to use it with the N°502, refer to the “Link2” section of the *Appendix*.

11. Trigger Outputs Used to activate other components in the home theater system, such as amplifiers, lights, window shades, and video screens. When the trigger is activated, a 12V DC signal is output. The trigger outputs use 3.5mm mini-jacks, labeled 1 to 4, and are programmable. For more information, refer to the “Triggers” section of *Chapter 3: Customizing the N°502*.

12. RS-232 Control port Provides serial control through a standard RS-232 connection. Refer to the separate document, *N°502 Serial Protocol*, for further details.

13. Ethernet port Used to support a network connection to connect to a computer, and for external or ML Net control. For information on how to set up and use the Ethernet port, refer to *Chapter 3: Customizing the N°502*.

14. Microphone Inputs Provides four 3.5mm input connectors. ***Only for use with the optional microphone kit during the automatic calibration process.***

2-6 **15. Analog Audio Outputs** Provide balanced XLR and unbalanced RCA connectors for the Main Zone analog audio output. The output connectors are arranged in four groups:

- **Front** – contains connectors for the Left/Right and Center outputs
- **Subwoofer 1** and **Subwoofer 2** – contains Left/Right connectors for the Subwoofer 1 & Subwoofer 2 outputs
- **Surround** – contains Left/Right connectors for the Surround (aka Side) outputs
- **Surround Back** – contains Left/Right connectors for the Surround Back (aka Rear) outputs

Note

Whenever an audio output is enabled or disabled in the Setup menu, both the balanced and unbalanced output connectors are affected.

16. Analog Audio Inputs Accept stereo analog audio inputs via two balanced (XLR) and four unbalanced (RCA) input connectors.

17. IR Input Accepts the input of IR (infrared) signals from other equipment. The 3.5mm jack accepts a stereo (tip/ring/sleeve) or mono (tip/sleeve) plug.

**18. 7.1-Channel/
5.1-Channel
Analog Audio
Input**

Provides eight connectors, labeled FL, FR, CTR, SUB, SL, SR, BL, and BR, for analog audio inputs. A 7.1 audio input signal uses all eight connectors; a 5.1 audio input signal uses only six connectors – FL, FR, CTR, SUB, SL, and SR.

19. AC Input

Provides AC power to the N°502 when the supplied power cord is connected from the AC Input connector on the N°502 rear panel to an electrical outlet.

Caution!

Before operating the N°502, verify that the voltage label near the AC input connector indicates an operating voltage compatible with the voltage level of the electrical outlet you intend to use.

**20. Remote Zone
Analog Audio
Output**

Provides one stereo pair of unbalanced RCA connectors for the Remote Zone analog audio outputs. These outputs can provide audio to a location outside of the primary listening space.

Remote Control Overview

The numbers in the Remote Control illustration above correspond with the summary list of items below.



2-8

- | | |
|------------------------------------|---------------------|
| 1. Navigation buttons (▲, ◀, ▼, ▶) | 10. Enter button |
| 2. Menu button | 11. Setup button |
| 3. Activity button | 12. Surround button |
| 4. Audio Profile button | 13. Volume button |
| 5. Video Profile button | 14. Preview button |
| 6. Function F1 button | 15. Mute button |
| 7. Function F2 button | 16. Zone button |
| 8. Function F3 button | 17. Standby button |
| 9. Light button | |

1. Navigation buttons

The ▲, ◀, ▼ and ▶ buttons provide basic navigation within the menu system of the N°502. The navigation buttons:

- highlight a new option from a list using the ▲ and ▼ buttons.
- select a new parameter value using the ▶ button.
- adjust an adjustment bar using the ▲ and ▼ buttons.
- exit a submenu using the ◀ button.
- enter a submenu using the ▶ button.

- 2. Menu button** Accesses the Audio Adjust menu to make real-time adjustments to various audio features of the N°502. In addition, when the Menu button is pressed from within any menu, the navigation returns to the previous menu level.
- 3. Activity button** Accesses the list of available Activities. Multiple presses of the Activity button scrolls through the list, and pressing the Enter button loads the new selection. The loaded Activity displays in red text. This button is also used to scroll through the Activity list while in Preview mode.
- 4. Audio Profile button** Accesses the list of available Audio Profiles. Multiple presses of the Audio Profile button scrolls through the list, and pressing the Enter button loads the new selection. The loaded Audio Profile displays in red text.
- 5. Video Profile button** Accesses the list of available Video Profiles. Multiple presses of the Video Profile button scrolls through the list and pressing the Enter button loads the new selection. The loaded Video Profile displays in red text.
- 6. to 8. Function buttons** The F1, F2, and F3 Function buttons provide direct access to a specific parameter without having to go through the menu structure. For more information, refer to the “Control Options” section of *Chapter 3: Customizing the N°502*.
- 9. Light button** Illuminates the remote control with a back light. Pressing the button a second time turns the back light off. The back light automatically turns off if no buttons are pressed for several seconds.
- 10. Enter button** Has two functions in the menu system:
- to advance through the menus.
 - to save a modified parameter value.
- 11. Setup button** Accesses the Setup menu to configure all system functions, advanced user options, and connectivity of the N°502 Media Console. In addition, pressing the Setup button closes the menu structure. For more information regarding how to set up the N°502, refer to *Chapter 3: Customizing the N°502*.
- 12. Surround button** Accesses the list of available surround modes. Multiple presses of the Surround button scrolls through the list; pressing the Enter button loads the new selection. The loaded surround mode displays in red text.

13. Volume button Pressing the (+) Volume button increases the volume, while pressing the (-) Volume button decreases the volume. The volume range for the Main Zone is 0 to 100 in 0.1 increments. The volume range for the Remote Zone is 0 to 100 in 0.5 increments.

The volume control for the Main and Remote Zones are independent of each other; adjusting the volume only changes the volume in the currently active Zone. For example, adjusting the Remote Zone volume does not affect the Main Zone volume.

When adjusting the volume, you may notice a REF tag positioned on the adjustment bar. REF indicates the Reference Volume level.

14. Preview button Allows the preview of video sources that are not part of the current Activity. Preview mode is only active when the front panel LED located to the left of the Preview button is illuminated.

15. Mute button Reduces the volume of the audio output within the Main Zone or Remote Zone. When the Mute function is active, the front panel Mute LED is lit. To deactivate the Mute control, simply adjust the Volume or press the Mute button until the front panel Mute LED is NOT lit. The actual volume level change of the Mute function can be modified in the Setup menu.

2-10 **16. Zone Button** Switches the N°502 controls between the Main Zone and Remote Zone. When the front panel Zone LED is lit, only the Remote Zone controls are active. Controls that are Main Zone specific (for instance, the Video Profile menu) are not accessible while the front panel Zone LED is lit.

17. Standby Button Activates and deactivates the Standby mode of the N°502. The Standby LED located directly above the Standby button on the front panel is illuminated when the N°502 is operational, and blinks slowly when the N°502 is in Standby mode.

Remote Control Versus Front Panel

Some menu navigation varies when using the front panel or the remote control. The table below identifies the *differences* between basic remote control and front panel navigation controls.

Note For simplicity, most instructions in this manual refer only to the remote control buttons.

Action	Remote Control	Front Panel
Enter the Activity Menu	Press the Activity button.	Turn the Activity Knob.
Select a Menu Option (Enter a Submenu)	Press the ▶ button or the Enter button.	Press the Enter button.
Exit a Menu	Press the ◀ button to go back one menu layer, or press the Setup button to exit the whole menu structure.	Press the Menu button to go back one menu layer, or press the Setup button to exit the whole menu structure.
Select a Parameter	Press the ▶ button or the Enter button.	Press the Enter button.
Change an adjustment bar	Press the ▲ or ▼ button.	Turn the Activity Knob.

Menu System Overview

The N°502 Media Console includes a comprehensive, graphical menu system to aid in setup, configuration, and daily operation. The menu system has two operating paradigms:

- **Activity Mode** provides the day-to-day interaction with the N°502 Media Console, and allows the user to make real-time changes to specific audio parameters.
- **Setup Mode** accesses the system setup parameters for system functions and connectivity. Setup Mode can only be entered by pressing the Setup button.

Note While in the menu structure: if the Menu button is pressed, the navigation returns to the previous menu level. Pressing the Setup button closes the menu structure.

While in Activity Mode, pressing the Video Profile, Audio Profile, or Surround buttons allows the user to change the Profile or Surround Mode associated with the current Activity. However, these changes are not saved when a new Activity is selected. To make any Profile or Surround Mode change permanent for the associated Activity, make the change while in Setup Mode.

2-12

Menu Path The menu system is designed to provide detailed information and yet remain simple to use. The top of *every* menu page displays a menu path, showing the current location in the menu system and the path taken to get there.

Activity Menu Pressing the Activity button displays the list of available Activities. The current Activity is displayed in red text. When scrolling through the list, the loaded video of each Activity is displayed in the Activity Preview window on the right side of the menu.

To load a new Activity, select one from the list and press the Enter button. Once loaded, the Activity remains active until a new Activity is selected.

Remote Zone Menu The Remote Zone provides audio to a secondary location outside of the primary listening space. The Main Zone Activity list is duplicated in the Remote Zone menu. The audio from any Activity can be selected for the Remote Zone.

Note If the Remote Zone Activity is set to Off, no audio is sent to the Remote Zone outputs. If the Zone LED is lit, Remote Zone controls remain active until the Zone button is pressed to switch back to the Main Zone.

Main Zone Audio Menu

MainZoneAudio
Audio Adjustments
Surround Mode Adjust

Accesses the Main Zone Audio menu to perform real-time audio adjustments to the Main Zone audio outputs. Press the Menu button to access the Main Zone Audio menu.

The Main Zone Audio menu contains:

- **Audio Adjustments menu** – makes real-time audio adjustments to selected audio parameters.
- **Surround Mode Adjust menu** – makes real-time adjustments to the available Surround Mode parameters.

Audio Adjustments Menu

-AudioAdjustments
Offsets
Left/Right Balance
Front/Back Fader
Room Correction: Off
Room Correction Adjust: Medium
Recall

The Audio Adjustments menu adjusts the Main Zone volume level by modifying the offsets, left/right balance, or front/back fader controls. In addition, you can control the level of Room Correction applied from the automatic calibration. Changes made to these parameters are system-wide changes that affect all Activities; the new settings are saved until another adjustment is made.

The Audio Adjustments parameters are:

- **Offsets** – adjusts the Offset volume of the Main Zone audio output. Individual Offsets are available for Stereo Front, Center, Surround, Back, Subwoofer 1, and Subwoofer 2. Selecting any of the Offset parameters opens an adjustment bar with a range of Off or –14.0dB to +14.0dB in 0.1dB increments. The zero Offset value is labeled as “Even”.
- **Left/Right Balance** – adjusts the volume level between the left side speakers and the right side speakers. Selecting the Left/Right Balance parameter opens an adjustment bar with a range of Off or –14.0dB to +14.0dB in 0.1dB increments. The zero Left/Right Balance value is labeled as “Even”.
- **Front/Back Fader** – adjusts the volume level between the front and rear speakers. Selecting the Front/Back Fader parameter opens an adjustment bar with a range of Off or –14.0dB to +14.0dB in 0.1dB increments. The zero Front/Back Fader value is labeled as “Even”.
- **Room Correction** – controls the application of the Room Correction values derived during the automatic calibration. This parameter can be On or Off.

2-13

Note

This parameter is not available for selection until the automatic calibration has been successfully completed.

Conditions that disable Room Correction include:

- Adding a new speaker to an existing Speaker setup. However, removing a speaker will NOT disable Room Correction.

- Lowering a crossover setting by two or more octaves.
- Changing the subwoofers from Mono to Stereo or from Stereo to Mono, or making any other subwoofer configuration changes.
- **Room Correction Adjust** – defines the level of Room Correction applied to the current Activity. The settings available are Low, Medium Low, Medium, Medium High, and High. The lowest setting only applies a minimal amount of Room Correction; the highest setting applies the full correction. The Room Correction Adjust parameter is not available for selection until the Automatic Calibration has been successfully completed and the Room Correction parameter is set to On.

Note Room Correction Adjust is disabled when Room Correction is set to Off.

- **Recall** – sets the Audio Adjust parameters to the factory default settings. The Offset, Left/Right Balance, and Front/Back Fader parameters are set to zero, or Even. The Room Correction is set to Off and the Room Correction Adjust is set to Medium.

Select OK to recall the factory default settings.

Select Cancel to exit without recalling the factory default settings.

2-14

Note The selected action is performed without pressing the Enter key.

The message “Audio Adjustment Settings Recalled” appears on the front panel and main displays when the adjustment settings are returned to the factory default settings.

Surround Mode Adjust Menu

The Surround Mode Adjust menu modifies the available Surround Mode parameters. Adjustments made in this menu are systemwide, affecting all applicable Activities.

For descriptions of the available surround mode parameter settings, refer to the “Surround Modes Parameter Descriptions” section of *Chapter 3: Customizing the N^o502*.

Status Panels

Status Panels provide both summary and detailed information regarding the current state of the N°502 Media Console. The Status Panels are information-only pages that have no selectable parameters.

There are two types of Status Panels – the Quick Status Panel and the Detailed Status Panel. With the exception of the Remote Zone Audio Quick Status Panel, all Status Panels relate to the Main Zone of the N°502.

Note Status Panels are not available during calibration.

Quick Status Panel

The Quick Status Panel is displayed whenever the current Activity is changed via the adjustment menus or the remote control Function buttons. The Quick Status Panel displays a short summary of the current Activity, acknowledging the change. The Quick Status Panel can also be accessed directly by pressing the ◀ button.

The Quick Status Panel displays for six seconds, then automatically closes. This condition and other display characteristics of the Quick Status Panel can be customized to your preferences. Refer to the “User Options” section of *Chapter 3: Customizing the N°502* for more information.

The Quick Status Panel identifies the current Activity in the upper left corner and the current Zone in the upper right corner. *All of the variables listed in the Quick Status Panel are directly related to the status of the Activity listed in the upper left corner of the panel.*

The Quick Status Panel includes:

- Volume - indicates the current volume level
- Signal - identifies the input type of the source signal
- Surround Mode - identifies the current Surround Mode
- Video & Audio Profiles - indicates the current Video & Audio Profiles

The information in the Quick Status Panel varies depending upon the current Activity and its setup.

The Remote Zone Quick Status Panel is only available for viewing when the Remote Zone is activated.

Detailed Status Panel

The Detailed Status Panel provides a comprehensive summary of the current Activity. To access the Detailed Status Panel, press the ▶ button.

The elements listed vary based upon the current Activity and its setup. Thus there may be more than one page of information; the top right corner of the menu identifies the number of pages. To access additional pages, press the ▶ button.

Note

The Detailed Status Panel is always shown on the front panel display and cannot be disabled.

The bottom half of each Detailed Status Panel page contains a meter diagram that indicates the input levels of each active channel. The meters show live data as long as the source of the current Activity is playing.

To close the Detailed Status Panel, press the ▶ button until it closes.

Note

If analog input clipping occurs, then the affected speaker in the meter section is indicated in red.

3

Customizing the N°502

The N°502 Media Console is customized through the Setup menu. The Setup menu is organized to proceed through the setup process in a logical manner. While nothing prevents the user from switching back and forth between menu options, the simplest way of setting up the system is to start from the top of the menu and work down. This is a particularly useful approach since some of the early decisions affect the options available in later menus.

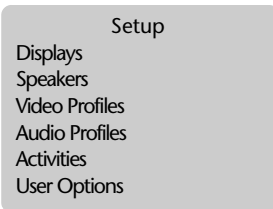

The Setup menu contains the following submenus:

- **Displays** – sets up video output parameters.
- **Speakers** – sets up the speakers, crossovers, and calibration features.
- **Video Profiles** – modifies the Video Profiles for the video processing.
- **Audio Profiles** – modifies the Audio Profiles for the audio processing.
- **Activities** – associates specific Profiles and Setups with each individual activity.
- **User Options** – sets up the general user preferences for system parameters.

3-1

Setup of the N°502 can be streamlined because of the Activity-based nature of the menu structure. A number of common Activities have already been set up at the factory and can provide a good starting place. We recommend selecting the presets that most closely resemble your system and then modifying them.

Add New, Name, & Delete

There are three commands that are available in every Display, Speaker, Audio & Video Profile, and Activity menu in the Setup mode. These commands – Add New, Name, and Delete – behave in the same manner in every Setup menu.

Add New

The Add New menu option creates a new Setup, Profile, or Activity. When selected, the N°502 creates a copy of the current Setup, Profile, or Activity and then saves the copy with a default name.

To add a new Setup, Profile, or Activity:

1. Press the Setup button and select Display, Speaker, Video Profile, Audio Profile, or Activity from the list. The loaded selection is displayed in red text.
2. Select Add New and then press Enter.

The N°502 creates the new Setup, Profile, or Activity by copying the loaded one and giving it a default name. Then the N°502 opens the Setup menu for the newly made Setup, Profile, or Activity. The menu path at the top of the screen indicates the default name.

Up to 10 different Setups and Profiles, and up to 20 different Activities, can be created and saved. When the full number have been created, the Add New option will not be available again until at least one Setup, Profile, or Activity has been deleted. The loaded Setup, Profile, or Activity cannot be deleted.

Name Any existing Display Setup, Speaker Setup, Audio or Video Profile, or Activity can have a customized name associated with it.

To Customize the Name of a Setup, Profile, or Activity:

1. Select the Setup, Profile, or Activity for which you want to change the name.
2. Select the Name option from the Setup menu.
3. The Name Selector, an interactive display screen used for all custom naming actions, now opens. The current name is displayed across the top line with a cursor blinking at the end. Refer to the "Name Selector" section found at the end of this chapter for further explanations on how to use it.
4. When finished customizing the name, select the Save button in the Name Selector to save the new name. The Name Selector screen closes and the menu navigation returns to the Setup menu. Observe that the menu path now contains the new name.

Delete The Delete menu option deletes the selected Setup, Profile, or Activity. The loaded Setup, Profile, or Activity, which displays in red text, cannot be deleted.

To Delete a Setup, Profile, or Activity:

1. Select the Delete option from the Setup, Profile, or Activity menu.

A warning message is displayed, indicating that the action cannot be undone.

2. Select Delete and press the Enter button to delete the Setup, Profile, or Activity. Select Cancel and press the Enter button to close the menu without performing the Delete action.

Deleting an existing Setup, Profile, or Activity is permanent and cannot be recovered. It can, however, be recreated by using the Add New command and making the modifications again.

Note Setups and Profiles cannot be deleted if linked to an Activity. The Delete menu option is grayed out and not accessible if the Setup or Profile cannot be deleted.

Setup Step 1: Displays

The first decision you need to make is **how many displays** your home theater system must support. For instance, you might want to use a front projection system for watching movies but prefer to watch cable television on a plasma display.

Create a new Display Setup for each display in your home theater system. So, in the example above, you'd make two new Display Setups – “Front Proj” and “Plasma”.

To create the new Display Setups:

1. Press Setup.
2. Select Displays and press Enter.
3. Select Add New and press Enter.
4. Select Name and press Enter.
5. Select the name of your new Display Setup using the Name Selector. If required, refer to the “Name Selector” section at the end of this chapter for instructions.
6. Select Save in the Name Selector and press Enter when finished creating your new Display Setup name. The N°502 saves the name and opens the new Display Setup menu. Observe that the menu path on the top of the screen indicates the new name.
7. Select Output Path and select the appropriate rear panel video output connector for the Display Setup you just created.
8. If you are creating more than one new Display Setup, press the ◀ button to return to Add New again.
9. Repeat Steps 3 through 7 until all you have created and named a new Display Setup for each display you plan to use with your home theater system.

For now, this is all you need to configure for each Display Setup. If desired, refer to the next section, “Display Setup”, for explanations of the other Display Setup options.

Display Setup

The Display Setup menu controls the setup parameters for the video output path, as well as the format of the video output signal.

Setup:Displays-Plasma
Name
Output Path
Display Format
Color Space
Resolution
Output Frame Rate
Zoom Ratio
Component Black Level
Delete Display

The Display Setup menu contains the following options:

- **Name** – customizes the name of each Display Setup. Refer to the “Add New, Name, & Delete” section found at the beginning of this chapter for more details.
- **Output Path** – identifies the active video output connector on the rear panel.
- **Display Format** – sets the aspect ratio of the output video signal.
- **Color Space** – identifies the color mapping format used for the video output signal.
- **Resolution** – identifies the video resolution of the video output.
- **Output Frame Rate** – selects the frame rate of the video output.
- **Zoom Ratio** – expands the video to fill the display area, reducing or eliminating the black bars resulting from letterboxing or pillarboxing.
- **SD Component Black Level** – sets the black level of the video output, for standard definition video.
- **Delete Display** – deletes Display setups that are no longer needed. Refer to the “Add New, Name, & Delete” section found at the beginning of this chapter for more details.

3-4

Output Path

The Output Path identifies which high-definition video output connector on the rear panel carries the active video output signal for the selected Display Setup. Three options are available – HDMI 1, HDMI 2, and Component. The output connectors can be assigned to multiple Display Setups, but only one video output can be active at any given time.

Note

For all source materials with HDCP (High-Bandwidth Digital Content Protection), video is disabled on the component output. However, the N°502 menus are still displayed. The Detailed Status Panel identifies the presence of HDCP source material.

Display Format

The Display Format parameter sets the aspect ratio of the output video signal. The aspect ratio is a width-to-height definition of the video display area. The N°502 has two options:

- 16:9 aspect ratio - standard for HDTV format, this aspect ratio is also referred to as *widescreen*. Almost twice as wide as it is high, it closely matches the aspect ratio of theatrical movie theaters. ***This setting should be used for displays with 16:9 aspect ratio.***

- 4:3 aspect ratio - most commonly used for SDTV format, this aspect ratio is almost square and is also referred to as *full-frame* or *full-screen*. ***This setting should be used for displays with 4:3 aspect ratio.***

When the source video and the display have different aspect ratios, letterboxing or pillarboxing is implemented.

- *Letterboxing* refers to the black bars placed above and below the picture to fill up the screen when the source material is in a widescreen format and the display is set to a full-frame format.
- *Pillarboxing* refers to the black bars placed to the right and left of the picture to fill up the screen when the source is in a full-frame format and the display is in a widescreen format.

Optionally, use the Zoom Ratio parameter to reduce or eliminate any black bars introduced by the aspect ratio of the source material.

Note

For information regarding how the video setup, DVD setup, and display settings interact to affect the display output, refer to the “Troubleshooting Display Formats” section of the **Chapter 4: Troubleshooting & Maintenance**.

Color Space

The Color Space parameter identifies the color mapping format used for the video output signal. Color space is a mathematical model that uses numerical combinations of red, green, and blue to map the colors of the video image. The available selections are:

- **YCbCr 4:4:4** – provides a higher-resolution video output for those higher sample rate formats available in some digitally formatted video source materials .
- **YCbCr 4:2:2** – standard compressed format common to DVDs and digitally formatted video source materials.
- **RGB Normal** – provides a standard RGB color conversion to the source video. This format is only available for HDMI outputs. Typically, this setting is used with home theater displays, such as plasma and front projections.
- **RGB Expand** – utilizes an expanded RGB color space definition to provide higher color resolution. This format is only available for HDMI outputs. Typically, this setting is used with PC-type displays, such as DVI interfaces.

For optimal results, we recommend setting the Color Space parameter to the format that matches the native format of the video display. The color space conversion of the input source material is then done by the N°502, using its state-of-the-art video processing technology, rather than by the video display, which may not have the same processing capabilities. If necessary, refer to the documentation included with the display to determine its native color space format.

Resolution The Resolution parameter identifies the video resolution, either interlaced or progressive, of the output signal. Interlaced video reduces bandwidth by loading only half of the frame at a time; first the even lines, then the odd lines. Progressive video loads the whole frame in sequence, providing better picture quality but also increased bandwidth usage as the frame rate is doubled.

The available Resolution selections are:

- **Standard Definition** – uses interlaced video at 480i or 576i.
- **Enhanced Definition** – uses progressive video at 480p or 576p resolution.
- **High Definition 720p** – uses progressive video at 720p resolution.
- **High Definition 1080i** – uses interlaced video at 1080i resolution.
- **High Definition 1080p** – uses progressive video at 1080p resolution. If the Component Video Output is selected, then this option is not available for selection.

For optimal results, we recommend setting the Resolution parameter to the format that matches the native format of the video display. The resolution conversion of the input source material is then performed by the N^o502, using its state-of-the-art video processing technology, rather than by the video display, which may not have the same processing capabilities. If necessary, refer to the documentation included with the display to determine its native resolution.

3-6

Note Resolution is a preference setting – if the preferred selection is not available, then the N^o502 selects a different resolution level. For example, if the Resolution is set to 1080p but the output is set to Component Video, the N^o502 outputs at a 1080i resolution level. The display EDID can also affect the allowed Resolution settings.

Output Frame Rate Selects the frame rate of the output signal. The Output Frame Rate identifies the number of frames transmitted per second. Available selections are 50Hz or 60Hz. For 1080p resolution, 24Hz is also available.

Zoom Ratio The Zoom Ratio parameter is used to fill the display area, reducing or eliminating the black bars resulting from letterboxing or pillarboxing. Before adjusting the Zoom Ratio parameter, ensure that the N^o502 has been properly configured to match the aspect ratio of the associated display by verifying that the Display Format parameter is set to the proper aspect ratio.

Available selections include:

- **Normal** – select when no zoom is desired.
- **Widescreen** – select when using a 16:9 display and the source material is widescreen anamorphic with a 2:35:1 aspect ratio.

- **Fill** – select when viewing content of a full-frame (4:3) source on a 16:9 display or when viewing the content of a letterbox (widescreen) source on a 4:3 display. In the second case, if the source material is an aspect ratio other than 16:9, the letterboxing may not be totally removed.
- **Fill + Widescreen** – select for the maximum amount of zoom. This is equivalent to having both Fill and Widescreen zoom modes active at the same time. Picture content may be cropped on the top, bottom, and sides.

The Zoom Ratio parameter removes or reduces the black bars from letterboxing or pillarboxing by zooming into the picture. This results in the slight cropping of image edges and a small amount of resolution loss due to image scaling, but no geometric distortions are added to the source materials.

SD Component Black Level

The SD (Standard Definition) Component Black Level parameter sets the black level of the video output. The black level is the adjustment required to reach a pure black, or true black, image display. Video displays are calibrated so that the black of the image display is true to the black information of the video signal. Available selections are 0 IRE and 7.5 IRE. Select the setting that best matches the capabilities of the display.

Note

This parameter is only available in 480i format on the component video output.

3-7

Setup Step 2: Speakers

The second decision you need to make is **how many speakers** your home theater system must support. Specifically, what is the maximum number of speakers and subwoofers that you plan to use?

Add a new Speaker Setup for the maximum number of speakers, including subwoofers, that you plan to use in your home theater system and name it “Master”. Or select the preset that most closely matches your maximum speaker configuration and modify it.

Calibrate the Master Speaker Setup, using the Automatic Calibration process described in the next section, “Speaker Setup”. This provides you with a maximum-speaker system that is fully calibrated for speaker distances, output levels, and Room Correction.

There is a specific purpose to creating this master speaker configuration, and it’s an important feature of the N°502 Media Console.

The main advantage of this master speaker configuration, coupled with the Add New functionality, is it dramatically reduces the amount of time needed to setup and calibrate the speakers of your home theater system.

Whenever *a speaker is added* to the system, the N°502 needs to be recalibrated. So, if you started your setup with a 2-channel Speaker Setup, when you added the surround speakers, you'd have to recalibrate the whole system. However, when *a speaker is deleted*, you don't need to recalibrate the system because all of the calibration settings for the other speakers remain the same.

Therefore, you could create up to 10 Speaker Setups while only having to calibrate ONE of them.

For example, if your maximum speaker configuration is a 7.2-channel system:

1. Create a Master Speaker Setup containing a 7.2-speaker system (Front L/R, Center, Surround L/R, Surround Back L/R, and Subwoofer 1 L/R).
2. Calibrate the Master Speaker Setup.
3. Create copies of the Master Speaker Setup by using the Add New option.
4. Modify the new Speaker Setups for different speaker configurations.

In this manner, you can make multiple speaker configurations – for example, 2-channel, 5.1-channel, 2-channel plus subs, etc. – while calibrating only the Master Speaker Setup, because in every other configuration you are only deleting speakers.

The following section, “Speaker Setup”, provides descriptions of the Speaker Setup options and instructions on how to perform the automatic calibration process.

Speaker Setup

The Speaker Setup menu controls all speaker-related configurations, including basic manual settings such as speaker distances and crossovers as well as access to the automated calibration procedures for speaker configuration and Room Correction.

The Speaker Setup menu:

- identifies the number of speakers in each Setup.
- selects the speaker crossover configuration.
- sets the crossover slopes.
- calibrates for speaker distances & output levels.
- calibrates the Room Correction.

The Speaker Setup enables the appropriate audio output connectors on the rear panel. Whenever an audio output is enabled or disabled, both the balanced and unbalanced output connectors are affected.

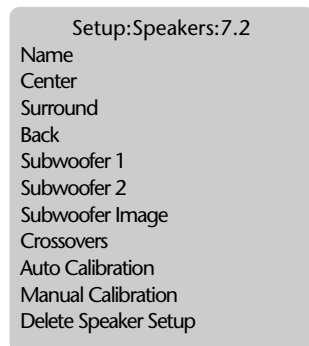

The Speaker Setup menu contains the following options:

- **Name** – customizes the name of each Speaker Setup. Refer to the “Add New, Name, & Delete” section found at the beginning of this chapter for more details.
- **Center** – activates or deactivates the Center output.
- **Surround** – activates or deactivates the Surround outputs.
- **Back** – activates or deactivates the Surround Back outputs.
- **Subwoofer 1** – activates or deactivates the Subwoofer 1 outputs.
- **Subwoofer 2** – activates or deactivates the Subwoofer 2 outputs.
- **Subwoofer Image** – identifies if the subwoofers are mono or stereo.
- **Crossovers** – sets the crossover frequency for each speaker.
- **Auto Calibration** – enters the automatic calibration process.
- **Manual Calibration** – provides access to manual calibration controls.
- **Delete Speaker Setup** – deletes Speaker Setups that are no longer needed. Refer to the “Add New, Name, & Delete” section found at the beginning of this chapter for more details.

Activating Surround Speakers

The Center, Surround, and Back menu options control the activation or deactivation of each speaker for each Speaker Setup. To activate speakers for the selected Speaker Setup, the Center, Surround, or Back menu option must be set to Yes. When the menu option is active, then the associated rear panel analog outputs (balanced and unbalanced) are also activated.

3-9

The speakers that can be activated are:

- **Center** – activates or deactivates the Center channel speaker.
- **Surround** – activates or deactivates the Surround, or Side, L/R (Left/Right) speakers. The speakers can only be activated or deactivated as a pair.
- **Back** – activates or deactivates the Surround Back, or Rear, L/R speakers. The speakers can only be activated or deactivated as a pair.

Note

The Front L/R speakers cannot be disabled. Therefore, there is no activation or deactivation control for the Front L/R speakers.

If the menu option is set to No, then the speaker is deactivated for the selected Speaker Setup and no signal is output to the associated rear panel connectors.

Activating Subwoofers

Although the N°502 supports up to four subwoofers, the outputs can only be activated as one or two L/R pairs.

The Subwoofer 1 and Subwoofer 2 menu options control the activation or deactivation of each Subwoofer L/R pair for each Speaker Setup. The Subwoofer 1 menu option must be set to Yes to activate a Subwoofer L/R pair for the selected Speaker Setup. When the menu option is active, then the associated rear panel analog outputs (balanced and unbalanced) are also activated.

If the menu option is set to No, then the subwoofers are deactivated for the selected Speaker Setup and no signal is output to the associated rear panel connectors.

Note

Subwoofer 2 is only available for selection if Subwoofer 1 is set to Yes.

Subwoofer Image

A single subwoofer can be used, even though a subwoofer pair is activated. The Subwoofer Image parameter identifies if the subwoofer outputs are mono or stereo. The selected option affects both Subwoofer 1 and Subwoofer 2. The available options are:

- **Mono** – sends the same mono subwoofer information to BOTH the left and right subwoofers. Use this setting for a system with a single subwoofer.
- **Stereo** – the left and right subwoofers are independent, so the information sent to each is driven by the input source and selected processing.

3-10

Crossovers

Controls the crossovers for each selected Speaker Setup.

:Speakers:7.2:Crossovers
 Frequency
 Subwoofer LPF
 Subwoofer Slope

Frequency

Sets the frequency for the crossover point of each speaker pair. The crossover frequency can be selected for the Front L/R, Center, Surround L/R, and Back L/R speakers.

:7.2:Crossovers:Frequency
 Front L/R
 Center
 Surrounds
 Back:
 Set All Full Range

The selectable crossover frequency range is 30Hz to 120Hz in 10Hz increments. Two additional settings are also available:

- **Full Range** – the speakers reproduce full range audio. Bass is redirected to all speakers that are set to Full Range.
- **Full Range Plus Sub** – provides additional bass to the front speakers below 60Hz. The front speakers operate at Full Range. The subwoofer outputs only reproduce frequencies below 60Hz.

To set all of the speakers to full range, select the Set All Full Range parameter. This parameter sets the Front L/R, Center, Surround, and Back speakers to Full Range. If this option is selected, the N°502:

- Does NOT set the Subwoofer 1 or Subwoofer 2 outputs to Full Range.
- Does NOT route any low-frequency information, other than the LFE channel information, to the subwoofer outputs.

Caution! In extreme cases, center and surround speakers may be damaged if sent lower frequency information than they are specified to handle.

Subwoofer LPF

Identifies the crossover point of the subwoofers. This setting affects both Subwoofer 1 and Subwoofer 2.

The Subwoofer LPF parameter can be configured in two ways:

- **Complementary** – the Subwoofer LPF is automatically set to the lowest crossover frequency of the active speakers, as determined by the Frequency crossover settings. With this setting, the output of the subwoofer(s) is designed to complement that of all other channels perfectly to ensure that all of the source information is reproduced.
- **Full Range** – no crossovers are enabled. This setting is provided for subwoofers with internal crossovers that cannot be bypassed.

3-11

Subwoofer Slope

Sets the slope of the subwoofer low-pass filter. The available options are 24dB per octave or 48dB per octave.

Speaker Calibration

The N°502 offers both automatic and manual calibration of speaker distances and output levels for each Speaker Setup. Calibration helps to ensure accurate output-signal arrival time and level at the primary listening position. However, calibration is not a substitute for proper speaker placement.

All calibration settings are saved with each individual Speaker Setup. Automatic calibration requires the HSG microphone kit. To order a HSG microphone kit, refer to *Chapter 1: Getting Started* for details.

The Automatic Calibration procedure optimizes the N°502 audio outputs and performs Room Correction. The procedure calibrates for:

- Room Correction
- Speaker Distances
- Speaker Levels

Manual calibration configures:

- Speaker Distances
- Speaker Levels

Note For optimal results, read all instructions before performing the Automatic Calibration procedure.

Room Correction

The Room Correction adjustment, which is part of the Automatic Calibration procedure, uses four microphones to measure the acoustic characteristics and modal properties of the listening room and then applies specific parametric filters to the outputs. The main advantages of the Room Correction adjustment are:

- it addresses what is important for the audio – the objective is not to make the numbers better, but to make the audio *sound* better.
- resonances are a feature of the room – treating them helps the entire room, and improves the bass uniformity of the room.
- the amount of correction can be adjusted by the listener.
- the calibration is simple and reliable – it can even screen out external noise sources.

3-12

For more information about the Room Correction adjustment and why it's an important part of enabling the system to run at optimal performance levels, refer to the "Understanding Room Correction" section in the *Appendix*.

Room Correction is not available with manual calibration.

Automatic Calibration

Setup:7.2:AutoCalibration
Check Microphones
Run Automatic Calibration

Follow the steps below to perform the Automatic Calibration procedure. The calibration is done in two steps: Check Microphones and Run Calibration. Until the Check Microphones test is performed successfully, the Run Calibration menu option is grayed out and not available. This prevents calibration errors due to potential microphone problems and verifies that the N°502 can accurately detect all of the microphones before beginning the calibration.

Note The HSG microphone kit is required for the Automatic Calibration procedure. Do not use other microphone brands.

Be sure to read and observe the care and handling instructions included with the microphone kit to ensure optimal microphone performance.

Caution! **The microphones and cables included in the HSG microphone kit are delicate and require careful handling. Dropping or otherwise physically abusing the microphones may cause errors during use or irreparable damage to the microphones. Treat the microphone cables carefully; do**

not sharply bend the wires or place objects on them. Finally, never make or break the microphone input connections unless the N°502 is placed in Standby mode or powered off.

To Perform Automatic Calibration:

1. Put the N°502 into Standby mode.
2. Connect the Mark Levinson microphone cables to the N°502 rear panel Microphone Input connectors. Ensure there is a good connection between the microphone cables and the connectors.

We recommend labeling each microphone with the microphone input number reflected on the N°502 rear panel connector, to make possible troubleshooting simpler.

3. Take the N°502 out of Standby mode.
4. Press Setup.
5. Select Automatic Calibration from the Speaker Setup menu and press Enter.
6. Select Check Microphones and press Enter.

**Check Microphone
Test**

The Check Microphones procedure:

- confirms that the microphones are properly connected and functioning.
 - calculates the average level of the microphones connected to the Microphone Input connectors to ensure that the microphone levels are consistent. This average-level calculation eliminates errors due to different individual microphone levels by allowing the N°502 to compensate for individual microphone sensitivities.
7. Place the four microphones in the listening space as instructed on the display. Both initial instructions and status information are displayed as the test proceeds.

Proper microphone placement is essential to achieving optimum calibration results. Pay particular attention to ensuring that the microphones are properly placed.

During the Check Microphones test, position the microphones:

- ✓ as close together as possible.
- ✓ relatively centered between, and equidistant from, the front left and front right speakers.
- ✓ in a clear line-of-sight path with all of the speakers.
- ✓ in a location unobstructed by furniture and other fixtures, where echoes will not obscure calibration noise signals.
- ✓ at least 2 feet (0.61m) from all speakers and walls, but within 30 feet (9.14m) of all speakers.

The following illustration provides an example of proper microphone placement during the Check Microphones test. All of the microphones are positioned as close together as possible in an unobstructed location that is equidistant from the front left and front right speakers.

PROPER Placement of the Microphones

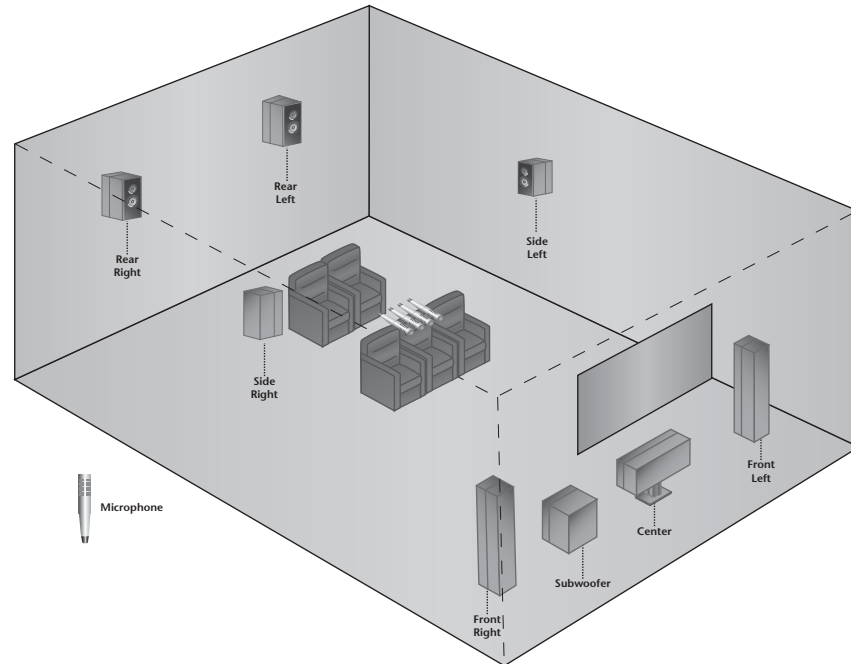

3-14

During the Check Microphones procedure, DO NOT:

- χ separate the microphones.
- χ scatter the microphones throughout the listening space.
- χ obstruct the line-of-sight path between the microphones and the speakers.
- χ position the microphones on the floor, on seat cushions, or in locations obstructed by furniture and other fixtures where echoes might obscure calibration noise signals.
- χ position the microphones within 2 feet (0.61m) of speakers and walls or more than 30 feet (9.14m) from any one speaker.

The illustration on the next page provides an example of improper microphone placement during the Check Microphones test. The microphones are scattered throughout the listening space in obstructed locations and out of the line-of-sight with the speakers, rather than positioned properly as close together as possible in a location that is equidistant from the front left and right speakers.

IMPROPER Placement of the Microphones

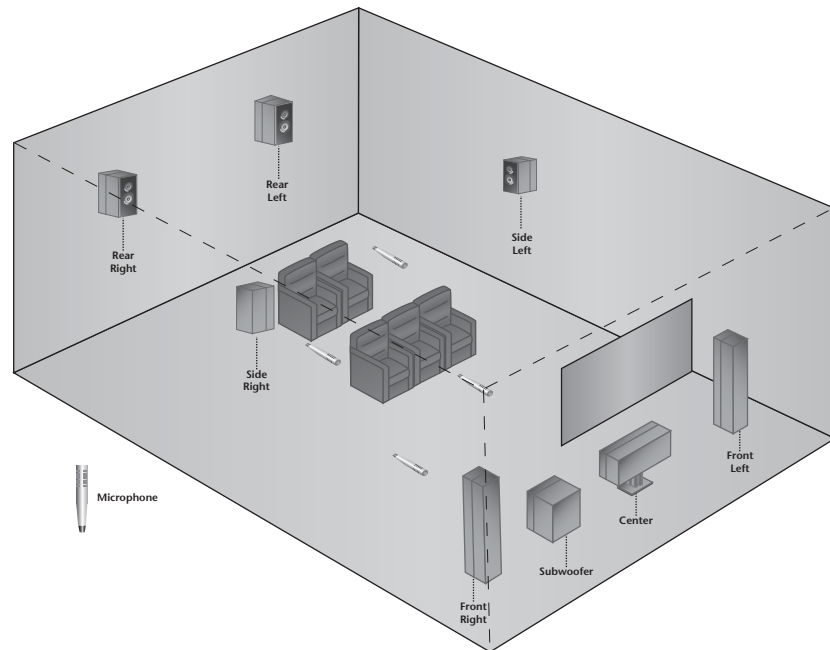

- Press the ► button to begin the test.

Caution!

During the test, the N°502 outputs calibration noise signals between 55dB and 95dB. These calibration noise signals are only sent to the Front Left and Front Right speakers. The master volume level is not adjustable while the test is in progress, but the test can be exited at any time by pressing the ◀ button.

3-15

Note

During the test, all input sources to the Main Zone are muted. However, the Remote Zone is NOT muted and continues to output the audio source. The test tones are NOT output to the Remote Zone.

- The test indicates when it's complete by displaying a Results message. To view the final results, press the ► button. Each microphone indicates either OK or Error.

To continue with the Run Calibration sequence, at least TWO microphones must pass the Check Microphones test. If fewer than two have passed, then the Check Microphones test must be performed again. Press the ► button of any failed microphone to see the reason for failure. There are four possible failure descriptions:

- **Not Detected** – the N°502 did not detect the microphone during the silence check.
- **Signal Too Low** – the microphone was detected; however, the signal level was inadequate.

- **Out of Range** – the microphone level is more than 20dB below the highest microphone level.
- **Too Much Room Noise** – the microphone level could not be determined because of excessive room noise.

If the calibration reports any of these errors, refer to the “Automatic Calibration Errors” section of *Chapter 4: Troubleshooting & Maintenance* for troubleshooting information.

10. If the Check Microphones test passed, leave the microphones connected and continue to Step 11.

If the Check Microphones test failed, then:

- ✓ check the microphones and microphone cables for proper connection or possible damage.
- ✓ remove or disable any possible external noise sources.
- ✓ press the ◀ button to return to the Automatic Calibration menu.
- ✓ return to Step 6 to perform the Check Microphones test again.

Continue to make adjustments and rerun the test until the test results indicate that at least two microphones have passed the test. If you have problems reaching this state, contact an authorized Mark Levinson dealer for assistance.

3-16

Run Calibration

11. Select Run Automatic Calibration and press Enter.

If the Run Calibration option is not available for selection, then the Check Microphones test has not passed. Return to Step 6 to perform the test again.

12. Place the four microphones in the listening space as instructed on the display. Both initial instructions and status information are displayed as the calibration proceeds.

Pay particular attention to ensure that the microphones are properly placed. The microphone placement determines whether the N°502 calibrates optimal Room Correction, speaker distances, and output levels for a single listening position, several listening positions in a single row, or several listening positions in the listening space.

Refer to the following examples to position the microphones for calibration. Select the microphone placement option that best meets the needs of the listening space.

For a *single listening position*, place the microphones:

- ✓ as close together as possible in the primary listening position.
- ✓ at the approximate position of the listener’s head.
- ✓ in a clear line-of-sight path with all of the speakers.
- ✓ in a location unobstructed by furniture and other fixtures, where echoes will not obscure calibration noise signals.

- ✓ at least 2 feet (0.61m) from all speakers and walls, but within 30 feet (9.14m) of all speakers.

The following illustration provides an example of proper microphone placement when calibrating for a single listening position. All of the microphones are positioned as close together as possible in a single listening position, allowing the N°502 to calibrate the optimal Room Correction, speaker distances, and output levels for that position.

PROPER Placement of Microphones – SINGLE Listening Position

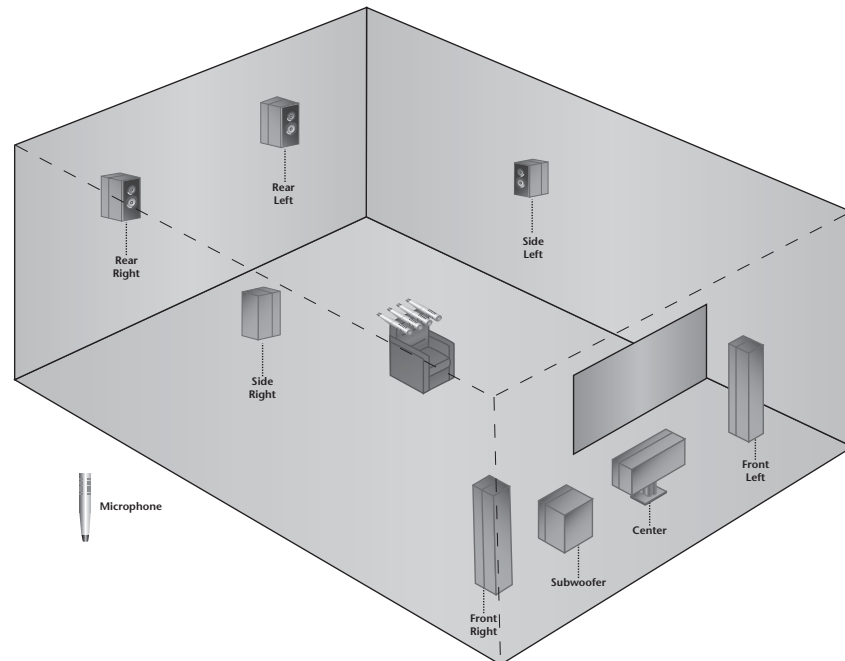

3-17

For *multiple listening positions in a single row*, place the microphones:

- ✓ at the approximate position of the listeners' heads.
- ✓ in a clear line-of-sight path with all of the speakers.
- ✓ in a location unobstructed by furniture and other fixtures, where echoes will not obscure calibration noise signals.
- ✓ at least 2 feet (0.61m) from all speakers and walls, but within 30 feet (9.14m) of all speakers.

The following illustration provides an example of proper microphone placement when calibrating for multiple listening positions in a single row. Each microphone is positioned in a different listening position within a single row, allowing the N°502 to calibrate the optimal Room Correction, speaker distances, and output levels for that row, at the expense of a single listening position.

**PROPER
Placement of
Microphones –
MULTIPLE
Listening Positions
in a Single Row**

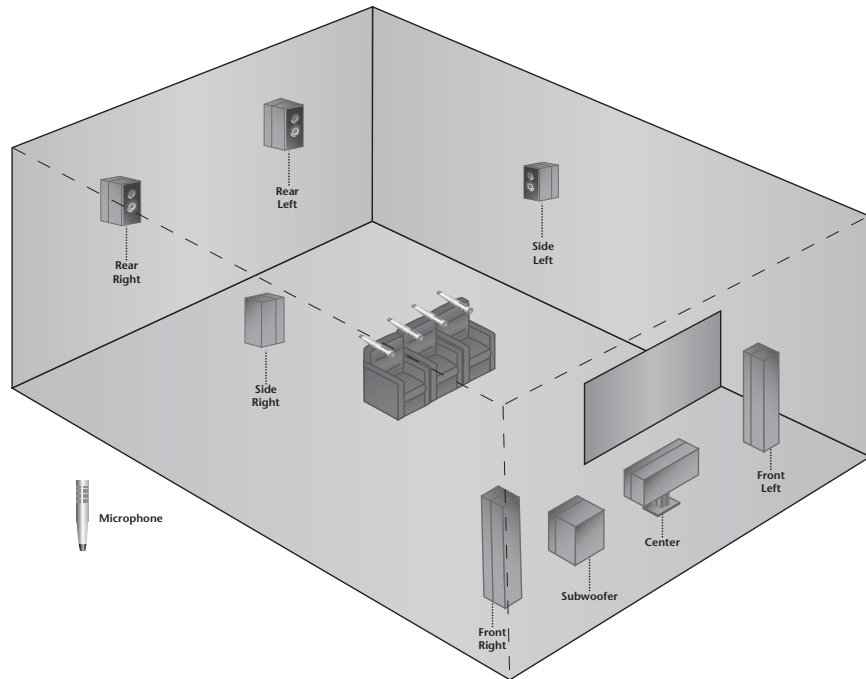

For *multiple listening positions in multiple rows*, place the microphones:

- ✓ at the approximate position of the listeners' heads.
- ✓ in a clear line-of-sight path with all of the speakers.
- ✓ in a location unobstructed by furniture and other fixtures, where echoes will not obscure calibration noise signals.
- ✓ at least 2 feet (0.61m) from all speakers and walls, but within 30 feet (9.14m) of all speakers.

The following illustration provides an example of proper microphone placement when calibrating for multiple listening positions in multiple rows. Each microphone is positioned in a single listening position in multiple rows, allowing the N°502 to calibrate the optimal Room Correction, speaker distances, and output levels for a larger listening area, at the expense of a single listening position.

**PROPER
Placement of
Microphones –
MULTIPLE
Listening Positions
in Multiple Rows**

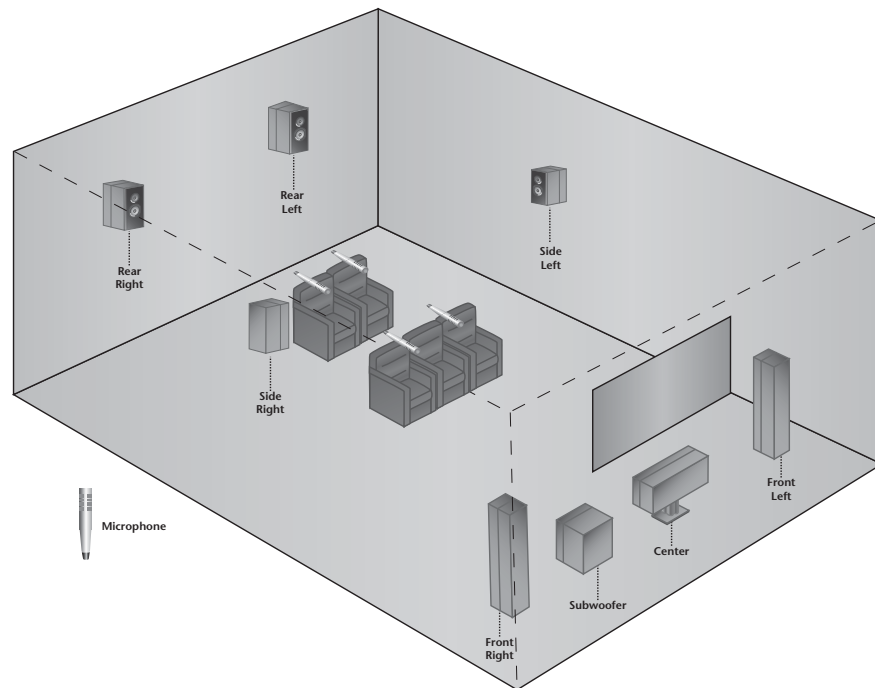

During the Automatic Calibration procedure, DO NOT:

- χ arrange the microphones along the perimeter of the listening positions or space.
- χ place the microphones in spots where the listeners' heads will not be positioned.
- χ obstruct the line-of-sight path between the microphones and the speakers.
- χ position the microphones on the floor, on seat cushions, or in locations obstructed by furniture and other fixtures, where echoes might obscure calibration noise signals.
- χ position microphones within 2 feet (0.61m) of any speaker or wall, or more than 30 feet (9.14m) from any speaker.

3-19

The following two illustrations provide examples of improper microphone placement for calibration. In the first example, the microphones are positioned on the floor along the perimeter of the listening space. In the second example, the microphones are positioned on the seat cushions instead of where the listeners' heads will be. These improper microphone placements make it difficult for the N°502 to calibrate optimal Room Correction, speaker distances, and output levels for the actual listening positions.

IMPROPER Placement of Microphones – Example 1

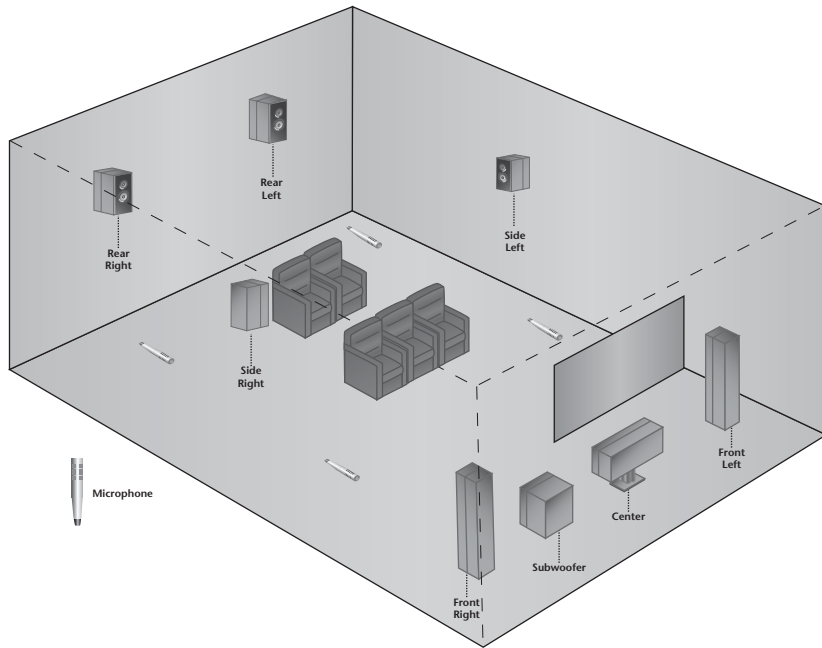

3-20

IMPROPER Placement of Microphones – Example 2

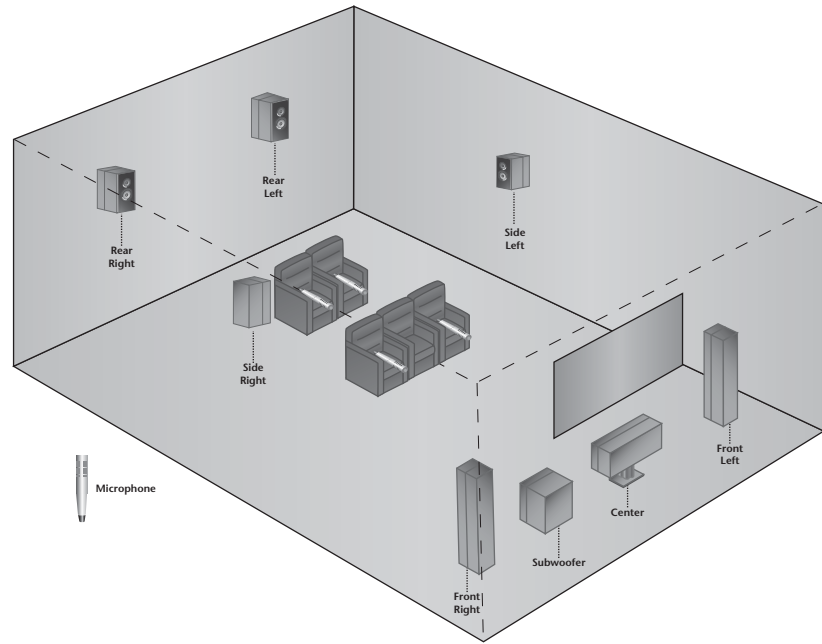

13. Press the ► button to begin the test.

Caution!

During the test, the N°502 outputs high audio levels. The master volume level is not adjustable while the test is in progress, but the test can be aborted at any time by pressing the ◀ button.

14. Read the warning on the display indicating that there will be high audio levels while the calibration is in process.

Note

During the test, all input sources to the Main Zone are muted. However, the Remote Zone is NOT muted and continues to output the audio source. The test tones are NOT output to the Remote Zone.

15. Select OK and press Enter when ready.

The display shows a 10-second countdown, allowing for time to leave the room before calibration begins.

You can abort the calibration at any time by pressing the ◀ button. The system reverts to its previous settings and no data from the aborted calibration is saved.

16. The test indicates when it's complete by displaying a Results message. The message identifies if the Room Correction, Auto Speaker Distances, and Auto Speaker Levels were calibrated successfully.

17. All of the calibration results can be viewed when the Automatic Calibration procedure is complete. Select the View Details option to view the detailed calibration results.

The Room Correction details indicate only if the Room Correction calibration was successful (Applied), if the speaker was not active during calibration (N/A), or if there is no Room Correction adjustment available for the speaker (- - -).

The Auto Speaker Distances results indicate the specific value for each speaker calibrated. The results are set to feet or meters, as identified by the Speaker Units parameter in the User Options menu. See the "User Options" section found later in this chapter for more details.

3-21

The Auto Speaker Levels result indicates the specific value for each speaker calibrated.

The full calibration details also indicate any errors that might have occurred during calibration of the Auto Speaker Distances and Auto Speaker Levels. There are six errors that may occur:

- **Speaker Out of Phase** – the microphones detected out-of-phase calibration signals, but the calibrated value is still accurate.
- **Signal Too Low** or **Speaker Output Too Low** – the microphones detected the calibration signals at an unusually low level.
- **Unable to Calculate** – the microphones didn't detect the calibration signals or the N°502 could not calculate a value.
- **May Not Be Accurate** – one or more of the microphones did not detect calibration signals at a reasonable level. The calibrated value might be inaccurate.
- **Speaker is Not Enabled** – the selected speaker is not activated in the Speaker Setup.
- **Speaker Output Too High** – the microphones detected the calibration signals at an unusually high level.

If the calibration reports any of these errors, refer to the “Automatic Calibration Errors” section of *Chapter 4: Troubleshooting & Maintenance* for troubleshooting information.

18. If the Run Calibration procedure passed, then proceed to Step 19.

If the Run Calibration procedure failed, then:

- ✓ check the microphones and microphone cables for proper connection or possible damage.
- ✓ press the ► button to return to the Automatic Calibration menu.
- ✓ return to Step 11 to perform the Run Automatic Calibration procedure again.

Continue to make adjustments and rerun the test until the calibration results indicates that the calibration has passed. If you have problems reaching this state, contact an authorized Mark Levinson dealer for assistance.

19. The Automatic Calibration procedure is now complete. Exit the Setup menu and place the N°502 into Standby Mode. Disconnect the microphone cables from the N°502 rear panel connectors and put away the microphones. Be sure to pay close attention to proper handling of the microphones and cables.

3-22

Manual Calibration

Setup:7.2-ManualCalibration
Speaker Distances
Speaker Levels

All Manual Calibration settings are saved with each individual Speaker Setup. The Manual Calibration menu allows the user to configure:

- **Speaker Distances** - the individual speaker distance adjustments.
- **Speaker Levels** - the individual speaker level adjustments.

The Manual Calibration menu does not use the HSG microphone kit.

Speaker Distances

The Speaker Distances parameter allows the user to set the distance for each individual speaker. The distance measurement is in feet or meters, as identified by the Speaker Distance Units parameter in the User Options menu. See the “User Options” section found later in this chapter for more detail.

To Manually Calibrate the Speaker Distances:

1. Select Speaker Distances from the Manual Calibration Setup menu and press Enter.
2. Select the Front Left speaker parameter and press Enter.
3. Use the ▲ and ▼ buttons to adjust. The speaker distance can be set from 0 to 40 feet (0 to 12m) with 6-inch (10cm) increments.
4. Repeat Steps 2 and 3 to adjust each speaker distance.

:SpeakerLevels
Internal Noise Test
External Noise Test

Speaker Levels

The Speaker Levels parameter allows the user to set the output level for each individual speaker. The Speaker Levels are calibrated using the Internal Noise Test or the External Noise Test.

Before starting a test, make the following preparations:

- obtain a Sound-Pressure Level (SPL) meter. An SPL meter is a device that measures the relative loudness of the speakers to ensure accurate output-level calibration.
- Calibrate the output levels from the primary listening position by placing the SPL meter at the approximate location of the listener's head when seated.
- Speakers that are not active cannot be adjusted. Verify that the appropriate speakers are activated before beginning.

Note

The N°502 sets the volume level to the Reference volume during the Internal and External Noise tests. Avoid adjusting the master volume level while the test is in progress.

Internal Noise Test

The Internal Noise Test sends an internal calibration noise signal to each Main Zone audio output connector, allowing for simultaneous output level adjustments.

To Manually Calibrate the Output Levels During the Internal Noise Test:

1. Set the SPL meter to "C" weighting and "SLOW" response.
2. Place the SPL meter in the primary listening position.
3. On the N°502, select the Internal Noise Test from the Speaker Levels menu. A warning message regarding high audio levels is displayed.
4. Select OK to begin the Internal Noise Test.
5. Select the Front Left Speaker in the Internal Noise Test menu. an adjustment bar is displayed.
6. Use the ▲ and ▼ buttons to adjust the adjustment bar for the output level until the SPL meter reads 75dB at the primary listening position.
7. Repeat Step 5 and Step 6 until all active output levels are calibrated.
8. Press the ◀ button to exit the Internal Noise Test menu.

External Noise Test

Use the External Noise Test to calibrate the output levels using an audio calibration disc. The External Noise Test activates an appropriate surround mode, as indicated in the table below, based on the current Main Zone input source. All custom surround mode menu parameter settings are ignored during the test. When the External Noise Test is complete, the surround mode returns to its custom setting.

Input Source	surround Mode for 5.1 Surround	surround Mode for 7.1 Surround
2.0 Dolby® Digital, Analog & PCM	Dolby PLII Movie	Dolby PLIIx Movie
5.1 Dolby® Digital	Dolby Digital	Dolby PLIIx Movie
DTS®	DTS-ES®	DTS-ES®
7.1 or 5.1 Analog & PCM	Multi-channel Standard	Multi-channel Standard

To Manually Calibrate the Output Levels During the External Noise Test:

1. Set the SPL meter to “C” weighting and “SLOW” response.
2. Place the SPL meter in the primary listening position.
3. On the N°502, select External Noise Test from the menu.
4. Begin playback of the external calibration source.
5. Select the Front Left speaker in the External Noise Test menu. an adjustment bar is displayed.
6. Use the ▲ and ▼ buttons to adjust the output level until the SPL meter reads the expected output, as defined by the external calibration source instructions, at the primary listening position.
7. Repeat Step 5 and Step 6 until all active output levels are calibrated.
8. Press the ◀ button to exit the External Noise Test menu.

Video Profiles

Setup:VideoProfiles:Film
 Name
 Deinterlacing
 Adaptive Threshold
 Film Detection
 Chroma Bug Correction
 Noise Reduction
 Brightness
 Contrast
 Saturation
 Tint
 Sharpness
 Delete Video Profile

Video Profiles provide the video processing and video output controls for the N°502 Media Console. The parameters include basic controls such as brightness or contrast, and state-of-the-art video processing technology that can enhance the video source material. Because of the Activity-based nature of the Video Profiles, you can create individual Video Profiles for each video input source or type, allowing you to tailor your viewing preferences to the media you're watching and minimize the time you spend adjusting the system.

The Video Profile Setup menu contains the following options:

- **Name** – customizes the name of each Video Profile. Refer to the “Add New, Name, & Delete” section found earlier in this chapter for more details.
- **Deinterlacing** – identifies the conversion type applied to the interlaced video.
- **Adaptive Threshold** – adjusts the adaptive processing, depending upon the video source material.
- **Film Detection** – detects the presence of film-originated material.
- **Chroma Bug Correction** – corrects the chroma bug caused by some mpeg decoding devices.
- **Noise Reduction** – adjusts how much noise is filtered out.
- **Brightness** – adjusts the brightness or overall tone of the video.
- **Contrast** – adjusts the contrast, or the variations between the lightest and darkest areas of the video image.
- **Saturation** – controls the saturation, or color intensity, of the video image.
- **Tint** – controls the color balance of the video image.
- **Sharpness** – enhances the sharpness of the video image.
- **Delete Video Profile** – deletes Video Profiles that are no longer needed. Refer to the “Add New, Name, & Delete” section found earlier in this chapter for more details.

3-25

In most cases, there is no need to change the Video Profile parameters from the default settings as these values are designed to be optimal with most properly adjusted video source materials. However, the Video Profiles are exceptionally useful when source-specific adjustments are needed, removing the need to constantly alter the global settings of the video display.

For instance, if you find that classic movies always seem to look washed out, you could make a “Classic Movie” Video Profile that modifies the Contrast and Brightness settings to improve the image. This Video Profile can then be loaded whenever you want to watch an old movie and the adjustment will be made automatically.

Deinterlacing

Deinterlacing is the process of converting the fields of an interlaced video signal into a progressive frame. This process may introduce some image degradation as it combines two fields. For example, since moving objects are in a different position in each field, when the frames are put together the moving objects don't match up exactly, which creates a combing effect (jagged edges that don't line up correctly). Image flickering can also be an issue, as well as various other video artifacts. However, the advanced processing of the N°502 can mitigate some of these artifacts.

The N°502 has three types of deinterlacing formats available for selection:

Temporal Filtering — applies a time-based filter between two or more adjacent fields. The filter softens the image to help smooth motion artifacts. This method is a linear deinterlacing technique.

Field Merging – combines adjacent fields using a weave-type algorithm. This method is a linear deinterlacing technique.

Adaptive – selects the deinterlacing method based on the motion of particular areas of the video frame. Still areas are processed differently than areas with fast motion to provide the best overall image. This method is a non-linear deinterlacing technique. *This mode should always be used, unless there is a specific artifact to address.*

3-26

Adaptive Threshold

Adjusts the adaptive processing applied to the video output signal. When the parameter is selected, an adjustment bar opens with a range of 0 to 15. The smaller numbers are better for fast moving scenes; the larger numbers are better suited for highly detailed static scenes. This parameter is only available if the Deinterlacing parameter has Adaptive selected.

Film Detection

Detects the presence of film-originated material so that the original film-frame sequence may be recovered by weaving together the appropriate video fields. This option can be turned On or Off; there are no additional settings.

Note

This parameter is most effective when the video input has not been previously scaled or processed by the source device and is a 480i or 576i interlaced format.

Chroma Bug Correction

Corrects the chroma bug caused by some mpeg decoding devices. This parameter can be turned On or Off; there are no additional settings.

Note

This parameter is only effective when the video input is an interlaced format – 480i, 576i, or 1080i.

Noise Reduction The Noise Reduction parameter reduces the video noise often present in analog input sources. Selecting this option opens an adjustment bar with a range from 0 to 64 in increments of one. The larger the number selected, the greater the suppression of the noise.

Brightness The Brightness parameter controls the lightness or overall tone of the image, just like the Brightness control found on a television or computer monitor. Technically, it controls the level at which black is reproduced on the display.

When the Brightness parameter is selected, an adjustment bar displays. The range of the Brightness adjustment bar is -64 to +64 in increments of one.

Note Trying to make the picture “blacker than black” by turning this control down too far reduces the visible detail during the dark scenes of the video.

Contrast The Contrast parameter controls the variations between the lightest and darkest areas in the image. Technically, it controls the level at which the peak white is reproduced, up to the maximum light output capability of the display.

Note Trying to exceed this maximum light output level reduces visible detail during bright scenes of the video. In extreme cases, trying to exceed this maximum can actually damage the video display.

3-27

When the Contrast parameter is selected, an adjustment bar displays. The range of the Contrast adjustment bar is -64 to +64 in increments of one.

Saturation The Saturation parameter controls the color intensity, or vividness, of the image. Visually, it controls the “saturation” of the color in the video signal. Technically, it controls the strength of the color portion of the video signal compared to the black-and-white portion of the signal.

When the Saturation parameter is selected, an adjustment bar displays. The range of the Saturation adjustment bar is -64 to +64 in increments of one.

Tint The Tint parameter controls the color balance of the image. Visually, the Tint parameter controls the “hue” or “color balance” of the video signal. Technically, it controls the phase of the color portion of the video signal.

When the Tint parameter is selected, an adjustment bar displays. The range of the Tint adjustment bar is -64 to +64 in increments of one.

Sharpness

The Sharpness parameter controls the amount of “sharpness enhancement” that is applied to the incoming video signal. The setting acts on the vertical and horizontal, as well as luminance and chrominance parameters to offer an enhanced depth in the picture as well as greater small-object detail. In general, the lower settings are applicable for digital displays and sources, while the higher settings may be preferred for CRT-based displays and analog sources.

Note

Indiscriminate use of the Sharpness parameter distorts the picture by adding unnecessary ringing and noise to the video image. If adjustment is required, turn up the Sharpness control until a slight “halo” forms around the transitions from light to dark or dark to light. Then back off the adjustment until the “halo” disappears.

When the Sharpness parameter is selected, an adjustment bar displays. The range of the Sharpness adjustment bar is 0 to +64 in increments of one.

Audio Profiles

Audio Profiles provide the audio processing and audio output controls for the N°502 Media Console. Because of the Activity-based nature of the Audio Profiles, you can create individual Audio Profiles for each input source or type, allowing you to tailor your listening preferences while minimizing the time you spend adjusting the system.

In most cases, there is no need to change the Audio Profile parameters from the default settings as these values are designed to be optimal with calibrated speakers.

The Audio Profile Setup menu contains the following options:

Setup:AudioProfiles:Movies
 Name
 Mono Signal
 2-Ch Signal
 Multi-Channel Signal
 LFE Mix
 L7 Auto Azimuth
 Surround Back Processing
 Dolby Digital Compression
 Delete Audio Profile

- **Name** – customizes the name of each Audio Profile. Refer to the “Add New, Name, & Delete” section found earlier in this chapter for more details.
- **Mono Signal** – assigns the default surround mode for any mono input source.
- **2-Ch Signal** – assigns the default surround mode for any 2-channel input source.
- **Multi-Channel Signal** – assigns the default surround mode for any multi-channel input source.
- **LFE Mix** – controls the output level of the LFE information sent to the subwoofers.
- **L7 Auto Azimuth** – allows the N°502 to automatically adjust the input signal to ensure that the output is sent to the appropriate channel for correct sound performance.
- **Surround Back Processing** – determines the type of decoding used for the surround processing of the audio signal.

- **Dolby Digital Compression** – reduces the wide volume level changes and increases the dialogue intelligibility at lower listening levels for Dolby Digital input sources.
- **Delete Audio Profile** – deletes Audio Profiles that are no longer needed. Refer to the “Add New, Name, & Delete” section found earlier in this chapter for more details.

Surround Mode Selection

The Mono Signal, 2-Channel Signal, and Multi-channel Signal menu options all relate to the selection of the default surround modes. The default surround mode is assigned to any incoming input source that matches the requirements for the surround mode defined.

- Select the Mono Signal surround mode that you want assigned to any incoming mono input sources for the active Audio Profile.
- Select the 2-Channel Signal surround mode that you want assigned to any incoming 2-channel input sources for the active Audio Profile.
- Select the Multi-Channel Signal surround mode that you want assigned to any incoming multi-channel input sources for the active Audio Profile.

The surround mode can always be changed from the Profile setting by using the Surround Mode Adjust button on the front panel or the Surround button on the remote control. However, these changes are temporary. If the Activity is changed or the incoming source is interrupted, the surround mode reverts to the saved Audio Profile setting.

3-29

Some of the surround modes are dynamic and depend upon the Speaker Setup and the incoming input source. Not all surround modes are available in all situations. Refer to the “Using Surround Modes” section found later in this chapter for more details.

LFE Mix

The LFE Mix parameter controls the output level of the LFE (Low Frequency Effects) information – the .1-channel information – that is sent to the audio output(s) labeled Subwoofer. Low frequencies from up to seven other channels may be combined with the LFE information to create the subwoofer output signal, which significantly increases subwoofer output levels.

Careful adjustment of this parameter provides proper tonal balance and reduces the risk of subwoofer overload. When the speaker setup does not include a subwoofer, the LFE information is mixed into the speakers that are set to Full or that have the lowest crossover points.

Selecting the LFE Mix parameter opens an adjustment bar with an adjustment range of –10 to 0dB in 1dB increments.

L7 Auto Azimuth

The L7 (Logic 7) Auto Azimuth parameter maximizes steering accuracy. When set to On, the N°502 continually monitors the 2-channel input signal and automatically adjusts the relative level and time offset of the input channels to ensure that signals are sent to the appropriate channels

with maximum separation. When set to Off, the accuracy of the selected surround mode varies among sources.

We recommend setting this parameter to On for film and broadcast sources, and to Off for music sources. The L7 Auto Azimuth parameter only applies when the Logic 7 surround modes are active.

Surround Back Processing

The Surround Back Processing parameter determines the type of decoding used for the surround processing of the audio signal. Two options are available - Dolby Digital EX decoding or DTS-ES decoding. Each option can be turned to Off, On, or Auto.

Dolby Digital Decoding

Dolby Digital Surround EX decoding is available when both the Surround and Surround Back speakers are present and Dolby Digital Surround EX decoding is active. Matrix decoding is then applied to derive the Surround Back channels.

When the Surround Back Processing>Dolby Digital EX parameter is set to:

- **Off** – Dolby Digital Surround EX decoding is NOT activated, regardless of the input source.
- **On** – Dolby Digital Surround EX decoding is always activated.
- **Auto** – Dolby Digital Surround EX decoding is activated for flagged 5.1-channel Dolby Digital Surround EX sources. If the incoming source is NOT flagged, then the decoding remains Off.

3-30

The table below shows the behavior of the Dolby Digital EX decoding parameter conditions.

Surround Back Processing Parameter Setting	5.1-Channel Dolby Digital Incoming Source		
	Dolby Digital	Surround EX (Flagged)	Surround EX (Non-flagged)
Auto	Dolby Digital	Dolby Digital Surround EX	Dolby Digital
On	Dolby Digital Surround EX	Dolby Digital Surround EX	Dolby Digital Surround EX
Off	Dolby Digital	Dolby Digital	Dolby Digital

DTS Decoding

The DTS-ES setting is designed to decode and play back 5.1-channel DTS, 5.1-channel matrix-encoded DTS-ES, and 6.1-channel discrete-encoded DTS-ES input sources. This mode is recommended for DTS input sources recorded with DTS-ES encoding.

DTS-ES decoding is available when both the Surround and Surround Back speakers are present and DTS-ES decoding is active.

When the Surround Back Processing>DTS-ES parameter is set to:

- **Off** – DTS-ES decoding is NOT activated, regardless of the input source.
- **On** – DTS-ES decoding is always activated.
- **Auto** – DTS-ES decoding is activated for flagged 5.1-channel DTS-ES sources. If the incoming source is NOT flagged, then the decoding remains Off.

The table below shows the behavior of the DTS-ES decoding parameter conditions.

Surround Back Processing Parameter Setting	DTS Incoming Source		
	5.1-Channel DTS	5.1-Channel DTS-ES (Matrix-Encoded)	6.1-Channel DTS-ES (Discrete-Encoded)
Auto	DTS	DTS ES	DTS ES
On	DTS ES	DTS ES	DTS ES
Off	DTS	DTS	DTS

Dolby Digital Compression

Reduces wide volume level changes and increases the dialogue intelligibility at lower listening levels for Dolby Digital input sources.

When set to On, the full compression is applied regardless of the current volume level. When set to Off, no compression is applied. The Auto setting provides compression only if the incoming source is formatted with compression information.

For listening to Dolby Digital input sources at a lower level, set to Auto or On – this is especially useful for nighttime listening to avoid disturbing others.

Activities

The Activities menu defines actions, such as “Watch a Movie” or “Play Games”, and then associates those actions to specific input connectors, Setups, and Profiles.

Each input, Setup, and Profile can be assigned to more than one Activity, but only one Display Setup, Speaker Setup, Audio Profile, and Video Profile may be assigned to any single Activity.

Setup:Activities:TV

Name
Display Setup
Video In
Input Aspect Ratio
Video Profile
Speaker Setup
Audio In
Audio Profile
Stereo Analog In Level
Main Audio Delay
HDMI Audio Output Options
Triggers
Move Activity
Delete Activity

The Activities Setup menu contains the following options:

- **Name** – customizes the name of each Activity. Refer to the “Add New, Name, & Delete” section found earlier in this chapter for more details.
- **Display Setup** – selects the Display Setup that is associated with each Activity.
- **Video In** – assigns the rear panel video input connector that is associated with each Activity.
- **Input Aspect Ratio** – identifies the aspect ratio of the input source.
- **Video Profile** – selects the Video Profile that is associated with each Activity.
- **Speaker Setup** – selects the Speaker Setup that is associated with each Activity.
- **Audio In** – assigns the rear panel audio input connector that is associated with each Activity.
- **Audio Profile** – selects the Audio Profile that is associated with each Activity.
- **Stereo Analog In Level** – adjusts the 2-channel stereo analog audio input levels.
- **Main Audio Delay** – delays the audio signal until the sound and picture are synchronized.
- **HDMI Audio Output Options** – identifies the format of the HDMI audio output signal.
- **Triggers** – identifies if the trigger outputs are activated by an Activity selection.
- **Move Activity** – changes the order of the Activity list.
- **Delete Activity** – deletes Activities that are no longer needed. Refer to the “Add New, Name, & Delete” section found earlier in this chapter for more details.

Display Setup

The Display Setup menu associates the Display Setup that is loaded by the N°502 for the current Activity. Selecting the Display Setup menu option displays the list of existing Display Setups. Select one to associate with this Activity.

If a new Display Setup is needed for this Activity, then back out of the Activities menu and select the Displays option from the main Setup menu. Refer to the “Displays” section found earlier in this chapter for more detail.

Video In

The Video In menu associates the specific N°502 rear panel video input connector(s) to be used for the current Activity. Selecting the Video In menu option displays the list of video input connectors available on the rear panel. Select one of the available connectors to associate it with this Activity.

Input Aspect Ratio

The Input Aspect Ratio parameter identifies the aspect ratio of the input signal. This parameter, combined with the Display Setup: Display Format parameter, ensures that all video sources are appropriately scaled. There are three available settings:

- **Auto** - sets analog and DVI source material to a 16:9 aspect ratio. HDMI input sources specify the aspect ratio of the source material.
- **16:9** - treats all incoming source material as 16:9, regardless of the existing format.
- **4:3** - treats all incoming source material as 4:3, regardless of the existing format.

This control is used to aid the N°502 in identifying the input aspect ratio for correct processing. Generally, it should be set to Auto. But if a source is not correctly identified, this control can be used to override the default processing.

Video Profile

The Video Profile menu associates the Video Profile that is loaded by the N°502 for the current Activity. Selecting the Video Profile option displays the list of existing Video Profiles. Select one to associate with this Activity.

If a new Video Profile is needed for this Activity, then back out of the Activities menu and select the Video Profiles option from the main Setup menu. Refer to the “Video Profiles” section found earlier in this chapter for more detail.

Speaker Setup

The Speaker Setup menu associates the Speaker Setup that is loaded by the N°502 for the current Activity. Selecting the Speaker Setup menu option displays the list of existing Speaker Setups. Select one to associate with this Activity.

If a new Speaker Setup is needed for this Activity, then back out of the Activities menu and select the Speakers option from the main Setup

menu. Refer to the “Speakers” section found earlier in this chapter for more detail.

Audio In

The Audio In menu associates the specific N°502 rear panel audio input connector(s) to be used for the current Activity. Selecting the Audio In menu option displays the list of audio input connectors available on the rear panel. Select one of the available connectors to associate it with this Activity.

Audio Profile

The Audio Profile menu associates the Audio Profile that is loaded by the N°502 for the current Activity. Selecting the Audio Profile option displays the list of existing Audio Profiles. Select one to associate with this Activity.

If a new Audio Profile is needed for this Activity, then back out of the Activities menu and select the Audio Profiles option from the main Setup menu. Refer to the “Audio Profiles” section found earlier in this chapter for more detail.

Stereo Analog In Level

The Stereo Analog In(put) Level parameter adjusts the 2-channel stereo analog audio input levels. Since analog audio sources can have a wide range of input levels, the N°502 allows the input levels to be independently adjusted for each Activity through the Analog In Level parameter.

3-34

Selecting the Stereo Analog In Level parameter opens an adjustment bar, with an available range of –18.0dB to +12.0dB in 0.5dB increments.

Main Audio Delay

The Main Audio Delay parameter delays the audio signal until the sound and picture are synchronized. This parameter should only need adjustment if the audio and video become out of sync. This can happen if the system uses any kind of post-processing on the video source, which tends to add a small delay to the video output. Adjusting the Main Audio Delay parameter on the N°502 delays the audio signal to compensate for any inherited video output delay, for each individual Activity.

Selecting this parameter opens an adjustment bar, with a range of 0.0ms to 500.0ms in 0.5ms increments.

HDMI Audio Output Options

This parameter identifies the format of the HDMI audio output signal. The available selections include:

- **Encoded** – the native format of the incoming signal is output. If the receiving device does not recognize the native format, the N°502 prompts a change to the audio output format.
- **PCM** – the incoming signal is converted to a downmixed PCM format before it is output.
- **Off** – turns off the audio output entirely. If Off is selected, then NO audio is output from the HDMI rear panel output connectors.

Note PCM 5.1 audio is downmixed to PCM 2.0 audio when using an HDMI output.

Triggers The N°502 provides four triggers that can be used to activate other devices, such as amplifiers, lights, window shades, and video screens. The triggers can be activated by selecting a specific Activity or by taking the N°502 out of Standby mode.

If activated by an Activity, then the Triggers parameter under the Activity menu is available for selection. If the Standby option is selected, then this parameter is grayed out and unavailable. For more information on triggers and how to set the activation state, refer to the “Triggers” section found later in this chapter.

Move Activity Changes the order of the Activity list. Use the ▲ or ▼ buttons to move the highlighted Activity to a higher or lower position within the Activity list.

User Options

- Setup:UserOptions
- About
- Display Options
- Audio Options
- Control Options
- Lock Options
- Restore Options

The User Options Setup menu sets the system preferences. This menu sets the master Volume and Mute levels, chooses the Status Panel display settings, restores the factory defaults, and other such system functions. In addition, system control options, such as trigger outputs and ML Net, are also accessed and controlled through the User Options menu.

3-35

About The About page is for information only; it identifies the version number of the N°502 operating software. This menu page has no selectable parameters.

To access the About page, press the Setup button and select the User Options menu.

Display Options Setup

- Setup:UserOptions-Display
- Preview
- Status Message Time
- Main Screen Status
- On Screen Display
- Menu Background
- Front Panel Status
- Display Intensity
- Speaker Distance Units

The Display Options menu customizes selected front panel and menu display features on the N°502. To access the Display Options menu, press the Setup button and select User Options from the Setup Menu.

The Display Options menu contains:

- **Preview** – controls where the Activity Preview mode is displayed. If set to On, then the Activity Preview is viewable on both the front panel display and the Main Zone displays. If set to Off, then the Activity Preview is only active on the front panel display. This option can be turned On or Off; there are no additional settings.

- **Status Message Time** – identifies the amount of time that the Quick Status Panels are displayed, either 6 Seconds or Always On. This parameter only applies to the Quick Status Panels; the Detailed Status Panels remain on-screen until manually closed. Refer to the “Status Panels” section of *Chapter 2: Basic Operation* for more information.
- **Main Screen Status** – determines if the Status Panels are displayed on the Main Zone display. If set to Off, Status Panels do NOT appear on the Main Zone display. This option can be turned On or Off; there are no additional settings.
- **On Screen Display** – determines if the N°502 menus, status panels, and messages are displayed on the Main Zone display. This option can be turned On or Off; there are no additional settings.
- **Menu Background** – controls the background of the menus. If the Menu Background option is set to On, then the menus are overlaid on whatever is currently playing on the Main Zone display. If the Menu Background option is set to Off, then the current display output cannot be viewed while the menu structure is accessed.
- **Front Panel Status** – determines if the Quick Status Panel is displayed on the front panel display. If set to Off, the Quick Status Panel does NOT appear on the front panel display. This option can be turned On or Off; there are no additional settings.

3-36

Note

The Detailed Status Panel is always shown on the front panel display. Setting the Front Panel Status to Off does NOT disable the Detailed Status Panel.

- **Display Intensity** – controls the brightness intensity level of the N°502 front panel display and all LEDs. Selecting this option displays an adjustment bar with four brightness levels - Off, Low, Medium, and High. This menu parameter performs the same function as the Display Intensity button on the front panel.

Note

If using the Monitor Out connector on the rear panel instead of the front panel display, then all front panel display controls affect the Monitor output, except for the Display Intensity button.

- **Speaker Distance Units** – identifies the units of measure for all Speaker Distances. The units of measure can be either feet or meters.

Audio Options Setup

```
:UserOptions:AudioOptions
Power On Volume
Max Volume
Mute Level
Remote Zone Volume
Multi-Channel Input Gain
```

The Audio Options menu customizes the Master Volume and Mute controls on the N°502. To access the Audio Options menu, press the Setup button and select User Options from the Setup Menu.

All of the volume levels are displayed on a scale of 0.0 (no sound) to 100.0 (extremely loud). All of the Audio Options menu settings affect both the Main Zone and the Remote Zone volume levels. The Remote Zone master volume levels are always copied from the Main Zone.

The Audio Options menu contains:

- **Power On Volume** – determines the volume level of the N°502 when taken out of Standby mode. Selecting this option displays an adjustment bar with a range of 1 to 50 in single increments.
The Power On Volume can also be set to Off (zero) and to Last Level. The Last Level option sets the volume to the level it was set to when last powered off or put into Standby mode.
- **Max Volume** – sets the maximum volume of the master volume control. This is useful to minimize potential damage to speakers or equipment due to unexpected high peaks in the audio tracks. Selecting the Max Volume parameter displays an adjustment bar with a range of 50 to 100 in single increments.
- **Mute Level** – sets the magnitude of the volume reduction introduced by pressing the Mute button. Pressing the Mute button can completely turn off the sound, or just substantially decrease the volume. Selecting the Mute Level parameter displays an adjustment bar with a range of –80 to –3 in single increments. The Mute Level can also be set to Fully Off, muting ALL Main Zone audio output sound.
- **Remote Zone Volume** – sets the Remote Zone volume to either Fixed or Variable. If Fixed is selected, then the Remote Zone volume is output at a volume level of 85.5 and cannot be adjusted. If the Variable option is selected, then the Remote Zone volume can be changed in the normal manner.

3-37

Note

If the Remote Zone volume is set to Variable, then the Max Volume and Power On Volume levels also apply to the Remote Zone Volume level.

- **Multi-Channel Input Gain** - this parameter adjusts the multi-channel analog audio input levels. This setting affects all Activities configured with multi-channel speaker arrays. The Multi-Channel Input Gain parameter has an adjustment range of –18 to +12dB in 0.5dB increments.

Control Options

The Control Options menu sets up the remote control function keys, trigger and network connectors, and ML Net control.

```
:UserOptions:ControlOptions
Remote F1
Remote F2
Remote F3
Trigger 1
Trigger 2
Trigger 3
Trigger 4
Network Setup
External Control
ML Net
```

The Control Options menu contains:

- **Remote F1 to Remote F3** – assigns specific commands to the Function keys on the remote control.
- **Trigger 1 to Trigger 4** – assigns the activation method of the four trigger outputs. Refer to the “Triggers” section found later in this chapter for more information on how to set up and activate the trigger outputs.
- **Network Setup** – assigns network details such as IP address and host name to enable use of the Ethernet port.

- **External Control** – identifies which port is being used by the external controller.
- **ML Net** – uses Ethernet to link together two or more Mark Levinson products. Refer to the “ML Net” section found later in this chapter for more information.

The N°502 has an internal Web page that provides an interface for any computer connected via the Ethernet port. Once the Network Setup is updated for your system, these internal Web pages can be accessed. Refer to the “Internal Web Pages” section found later in this section for more details about the use of these pages.

Remote Function Buttons (F1 to F3)

:ControlOptions:RemoteF1
 Unassigned
 Audio Adjust Functions
 Surround Modes
 Audio Profile Functions
 Activity Functions
 Display Functions
 Control Functions

The N°502 remote control has three function buttons labeled F1, F2, and F3. These function buttons allow the user to identify a specific menu parameter, one per button, that can be accessed directly, without going through the menu structure.

To assign the menu parameter that each button calls, the button has to have a function associated to it. Press the Setup button and select the User Options >Control Options menu. Each remote button has a separate menu for selecting the function it will control. Select the menu for the button to be set up.

The Remote Function menus, Remote F1 to Remote F3, identify what parameters can be accessed directly. To make finding the commands easier, the functions have been grouped into categories:

- Audio Adjust Functions
- Surround Modes
- Audio Profile Functions
- Activity Functions
- Display Functions
- Control Functions

Select a functional group, then specific commands are available for selection. The command highlighted in red is the currently assigned command. If no commands have been previously assigned, then nothing is highlighted in red and the status of the Function button is listed as Unassigned.

All of the Remote Function buttons have a factory default value of Unassigned. To clear any Remote Function button of an assigned command, select and save the Unassigned parameter to that button.

Function button assignments behave exactly the same as any command in the menu structure – there is no functional difference. In addition,

functions that are available in both Activity mode and Setup mode can be assigned to a remote function button.

Note

Since using a function key bypasses menu path navigation, the cursor always highlights the top of the menu list, not the last-selected menu item.

To Set a Remote Function Button:

1. Press the Setup button.
2. Use the ▲ or ▼ buttons to select User Options and then press the Enter button.
3. Select Control Options and then press the Enter button.
4. Select the Remote Function option to be set and then press the Enter button.

The status of each Remote Function button is also displayed. At the factory default state, each of the Remote Function buttons should display “Unassigned”.

5. Select the category for the command that the Function button will control and then press the Enter button.
6. Highlight the desired command and press the Enter button. If another command has been previously chosen or is set to one of the other Function buttons, it will be highlighted in red.

Once a command is selected, the menu returns to the category page, and the red cursor now highlights the category of the newly selected command.

7. Press the ◀ button to return to the Control Options menu. Note that the status of the Function button just set should identify the new command selected.

In some cases, the function that you want to assign may be part of a multiple-choice list. When the Function button is selected, a pop-up window appears on the display. Multiple presses of the Function button scrolls through the list. When you stop scrolling, that parameter automatically loads and the pop-up window closes.

3-39

Network Setup

-ControlOptions-NetworkSetup
Host Name
DHCP
Auto IP Address
Renew IP
Static IP Address
Subnet Mask

To setup the N°502 for network operation via the Ethernet port, first update the Network Setup menu.

The Network Setup menu has several parameters:

- **Host Name** – indicates the network name given to the N°502. The default name is “ML502”. Selecting this parameter opens the Name

Selector menu. See the “Name Selector” description found at the end of this chapter for information on how to use the Name Selector to edit the Host Name.

- **DHCP** – turns DHCP (Dynamic Host Configuration Protocol) capability On or Off. When activated, DHCP assigns a unique IP (Internet Protocol) address to the N°502. We recommend that you leave DHCP set to On.
- **Auto IP Address** – displays the dynamic IP address assigned by DHCP, when DHCP is active. If DHCP is not active, then no IP address is displayed. This is an information-only display and has no selectable options.
- **Renew IP** – refreshes the dynamic IP address. This is useful if the network connection has stalled; selecting this option triggers DHCP to assign a new IP address.
- **Static IP Address** – provides a fixed, or “static”, IP address. This IP address is NOT automatically selected, it must be entered. If DHCP is On, then the Static IP address is not used. Use the ◀, ▶, ▲ and ▼ buttons to enter the IP address.
- **Subnet Mask** – identifies the Subnet Mask for the N°502. This IP address is automatically assigned by DHCP. If DHCP is Off, then you will need to enter this manually, and it must agree with the Subnet Mask address of the router.

3-40

To Change the Static IP Address or Subnet Mask:

Selecting the IP Address or the Subnet Mask option identifies the current address and provides the editing controls necessary to change the address. There are four red cursor marks, similar to the highlighter used in the Name Selector, that surround one section of the address.

Use the ◀, ▶, ▲ and ▼ buttons to modify the current IP address:

- Pressing the ▲ and ▼ buttons changes the number.
- Pressing the ◀ and ▶ buttons moves the cursor marks to the next section of the address.
- Use the ◀ and ▶ buttons to highlight the Enter tab.
- With the Enter tab highlighted, press the Enter button to save any changes.
- From the Enter tab, press the ◀ button to highlight the Cancel tab.
- With the Cancel tab highlighted, press the Enter button to exit without saving any changes.

External Control

External control commands can be received over both the ethernet and RS-232 ports. The external control parameter identifies which port is being used by the external controller.

Lock Options

-UserOptions-LockOptions
Surround Modes
Audio Adjust
Setup

The Lock Options menu allows you to lock certain setup features and customized parameters so that they may not be changed. Each of the parameters in the Lock Options menu can be Locked or Unlocked.

To access the Lock Options menu, press the Setup button and select the Lock Options menu.

Access to the Lock Options menu can never be locked. So even if the Setup menu is Locked, the Lock Options menu can be accessed in order to Unlock the Setup menu.

Restore Options

The Restore Options menu provides access to the Restore Factory Settings parameter, which restores all parameter settings to the factory defaults.

Restoring the factory settings of the N°502 erases all currently customized settings, calibration values, and setup parameters. Once the factory settings have been restored, all other values are permanently deleted.

Before performing this function, make sure that you've saved the N°502 configuration settings. We've provided a configuration tool to make this easier to accomplish. The N°502 can download your configuration settings to a file on the hard drive of a computer, via the Ethernet port on the rear panel of the N°502. For more information regarding how to save your configuration, refer to the "Restoring Factory Default Settings" section of *Chapter 4: Troubleshooting and Maintenance*.

When Restore Options is selected, a warning message is displayed. If you're sure you want to restore the factory defaults, select Restore and press the Enter button. Otherwise, select Cancel and press the Enter button to exit out of the menu without restoring the factory defaults.

Note

All parameter default settings are identified in the Menu Trees, which can be found in the *Appendix*.

Triggers

The N°502 provides four trigger outputs that can be used to control other products, such as amplifiers, lights, shades, and video screens. The triggers

can be activated by selecting a specific Activity or by taking the N°502 out of Standby mode.

For example, you might have an Activity Setup called “Movie”. When the Movie Activity is selected, Trigger 1 activates to lower the video screen for your front projection system, while Trigger 2 activates to close the window shades. This example has Trigger 1 and Trigger 2 activated by an Activity.

If Trigger 3 is set to activate when the N°502 is taken out of Standby mode, it might send a signal to the amplifiers so that they are powered up at the same time.

Trigger Activation

The first decision you need to make is how you want the trigger outputs activated – by the selection of an Activity or by leaving the Standby mode.

To set the activation method, enter the Setup>User Options>Control Options menu. This menu has four available selections, Trigger 1 to Trigger 4, allowing you to set the trigger activation methods individually.

Select the trigger location that you want to set up, and then select the activation method:

- **Out of Standby** – activates the trigger when the N°502 is removed from Standby mode.
- **On Demand Only** – activates the trigger *only* when a specific Activity is selected.

When activated, the trigger supplies a 12V signal to the associated rear panel Trigger connector.

On Demand Only Setup

When the On Demand Only option is selected, you must then configure the specific Activity that turns on the trigger.

To associate the Activity to an On Demand Only trigger, go to the Setup>Activities menu. Select the Activity that you want the trigger activation associated with and then select the Triggers option.

The triggers can be set to two different states for each specific Activity:

- **Trigger On** – selecting the Activity supplies a 12V signal to the associated rear panel Trigger connector.
- **Trigger Off** – the Trigger supplies no voltage to the associated rear panel Trigger connector when the Activity is selected.

Note

Any of the Trigger Outputs can also be assigned to a Function key on the remote control. In this case, the Trigger Output is activated whenever the Function key is pressed.

Internal Web Pages

The N°502 supports network connection to a computer through the Ethernet port. The Internal Web Pages act as the N°502's interface with the network. These pages provide:

- **Download/Upload Configuration** - the N°502 configuration and calibration settings can be downloaded to a computer via the rear panel Ethernet port. Previously saved configurations can also be uploaded in the same manner. For more information, refer to the "Saving the N°502 Configuration" section of the *Appendix*.
- **Software Upgrade** - the interface for upgrading the N°502 operating software. This interface will be used for any future software upgrades. A separate document with further explanation will be available with future software upgrades.
- **Error Reporting** - the Error Log page tracks ML Net or system-related error messages. This page is a diagnostics tool for Mark Levinson Customer Service use.

Note

To access the Internal Web Pages requires proper network setup on both the N°502 and the computer. To set up the computer, refer to your computer operating manual. To set up the N°502, refer to the "Network Setup" description in the "Control Options" section found earlier in this chapter.

3-43

ML Net

The ML Net protocol allows you to control two or more Mark Levinson products simultaneously via the Ethernet port.

To use ML Net, the following conditions are required:

- only compatible with Mark Levinson products.
- all products must have Ethernet communication ports.
- an IP router with Auto-detect, capable of 10baseT or 100baseT operation.

Refer to the product documentation of each Mark Levinson product to verify compatibility.

Note

Since ML Net operates through the use of a router and the Ethernet connection, all devices must have networking capability. To set up the N°502 for network operation, refer to the "Network Setup" description in the "Control Options" section found earlier in this chapter.

Masters and Slaves

ML Net uses a single “Master” device to control specific functions of other ML Net-capable Mark Levinson products. An ML Net system can only have one “Master” device; all other devices in the system become “Slaves”. Slave devices receive and respond to the commands of the Master device.

An ML Net system can simultaneously support one Master device and up to 16 Slave devices. In most cases, the Master device is the N°502 Media Console. The N°502 can never be a Slave device.

Note

If assigning a 17th Slave device is attempted, the ML Net Setup and ML Net Status menus indicate that the designated Slave device remains in an Unassigned state.

The Master device performs the following ML Net functions:

- **Status Reporting** – status conditions of the assigned Slave devices can be reported to the Master device; the status includes Temperature, Session Time, Total On Time, and Fault Reporting.
 - **Display Intensity** – the Display Intensity level of the front panel display and LEDs on the Master device is replicated on all assigned Slave devices.
-

3-44

Note

The Display Intensity master command does NOT change the brightness intensity of the amplifier LEDs.

- **Standby State** – the Standby state of the Master device is replicated by all Slave devices. When the Master device is put into Standby mode, all assigned Slave devices go to Standby mode. When the Master device is taken out of Standby mode, the Slave devices should also come out of Standby mode.
- **Synchronized LEDs** – the Standby LEDs of the Master device and all assigned Slave devices blink in unison.

Connecting the Devices

The first step is to connect all of the devices together. *Ensure that all components are powered Off or in Standby mode before connecting to the Ethernet ports.*

To set up an ML Net system:

- All devices must be connected to an Auto-Detect capable router using straight-through Cat. 5 cables.
- Each device must be connected to the same subnet, which must include a DHCP server. In most cases, this functionality is part of the router.
- Each device must have a unique IP address (usually assigned via DHCP server).

The figure below illustrates a typical ML Net setup:

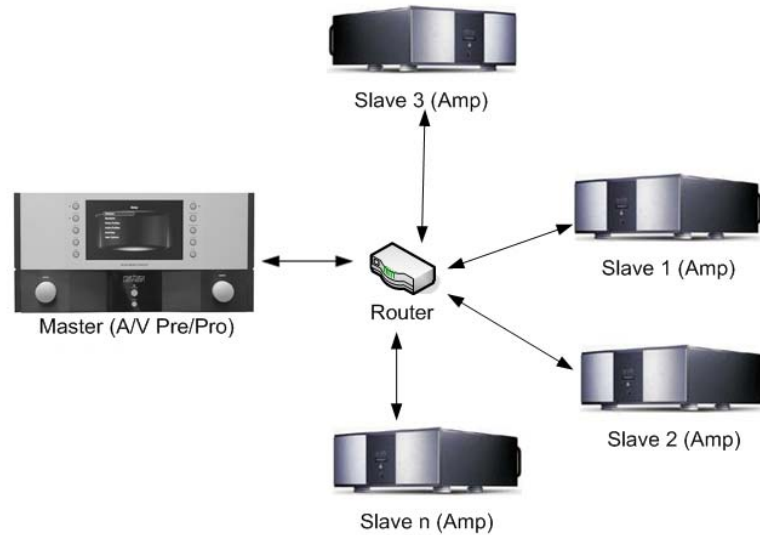

If more devices are desired than the router can handle, connect the additional devices first to a switch, then connect the uplink of the switch to a normal port on the router.

Once connected, power on the devices **one at a time** to ensure proper functioning of the ML Net controls. The N°502 Media Console **must** be powered on first. Allow each device to complete the initialization sequence before proceeding to the next device.

3-45

Note

If a Trigger control and ML Net are both active on the same device, the Trigger control takes priority.

Discovering Slaves

-ControlOptions-MLNet
ML Net Setup
ML Net Status

Before the Master device can control any Slave device, the Slave devices must be “discovered” and assigned to the Master device.

The N°502, as the Master device, searches for other devices via the Ethernet connection, compiling a list of discovered devices and their current status. Each discovered device must then be assigned to the ML Net system.

To assign the Slave devices to the N°502, go to the ML Net Setup menu, located in the Setup: Control Options menu.

All of the devices found by the N°502 are listed in the ML Net Setup menu. The discovered devices are described by the following states:

- **Unassigned** – discovered device that is not assigned to the N°502 or any other Master device.
- **Assigned** – discovered device that is assigned (by the user) to the N°502.

- **Other** – discovered device is assigned to a different Master device.
- **Inactive** – previously discovered device was assigned to the N°502 but is no longer visible due to a lost connection.

Each listed device can be assigned or unassigned to the ML Net system. If you choose to unassign an already assigned device, a warning message is displayed asking for confirmation before unassigning it.

Note

In some cases, it may take a minute or two before changes occur in the ML Net Setup and ML Net Status device information listings. This delay is due to the nature of the Ethernet connection, as device status information may not be immediately noted by the router.

Slaves can only be assigned to a Master from within the menu system of the Master. You cannot assign Slaves to a different Master than the one you are accessing.

ML Net and Link2

A system can use ML Net and Link2 together, but the Link2 control takes precedence. In this case, the ML Net Slaves enter a Status-Only mode whenever the Slave is under Link2 control. The Status-Only mode allows the notifications and status requests, but any attempt made by the Master to change the state of the ML Net Slave is ignored. The Slave sends a message to the Master indicating it's in Status-Only mode.

3-46

Status Reporting

The ML Net system provides Slave status information on the Master device. These status reports are information-only and can be accessed on the N°502 in the ML Net Status menu. Select any assigned Slave device from the menu list and the following status information is displayed:

- **Temp (Temperature)** – identifies the current operating temperature of the Slave device. The status field can include up to eight temperature values, depending upon the capabilities of the Slave device.
- **Session Time** – identifies the amount of time that the Slave device has been powered On. This time resets each time the Slave is put into Standby mode.
- **Total On Time** – identifies the total amount of time that the Slave device has been powered On since its manufacture. Putting the Slave into Standby mode does NOT reset this time.

If a Slave device is Inactive or Unassigned, then the status information is not available. A Slave device is assigned to a different Master; the status information is also not available.

Note

If the N°502 cannot find any Slave devices, the message "No Devices Found" is displayed on the ML Net menu pages.

Fault Reporting

The N°502, as the Master device, is capable of reporting selected error conditions of the Slave devices. Error messages are posted on the front panel and main displays when the failure event occurs in the Slave device. The error message identifies the failure and the identity of the Slave device experiencing the failure.

The error conditions of the Slave devices that the N°502 can report are:

- **Slave Device DC Offset** – indicates that the Slave device is experiencing a signal-related fault.
- **Slave Device Over Current** – indicates that the Slave device is experiencing an over-current condition.
- **Slave Device Over Temperature** – indicates that the Slave device is overheating.
- **Signal** – indicates that the Slave has had a general signal fault.
- **Power** – indicates that the Slave has had a power failure.
- **Unknown** – indicates that the Slave has a fault condition that is not supported by the current ML Net version.

Using Surround Modes

The N°502 Media Console logically presents the available list of surround modes based upon the detected input and the system setup. This process simplifies surround mode selection by presenting only the relevant modes for each Activity. The available surround modes are then assignable to any relevant Activity.

3-47

Selecting A New Surround Mode

The surround mode for the current Activity can be changed via the Surround button.

1. Press the Surround button to display the list of surround modes. This list is dynamically built by the N°502 and includes all of the modes available for the current Activity, based on the Activity setup and the incoming source.
2. Use the ▲ and ▼ buttons to scroll through the list. The current mode is displayed in red text. Repeated presses of the Surround button also scrolls through the list.
3. Press the Enter button or the ► button to select the desired surround mode. The selected surround mode now displays in red text, indicating that it is now the active mode.
4. To close the list, press either the ◀ button or the Menu button.

The current Activity now has a new surround mode. However, this is a temporary change and may be lost when a new Activity is selected or if the input source is interrupted.

Surround Mode Descriptions

Each of the available Surround modes is described below. The table included with each description indicates the corresponding Surround mode parameters, their factory default settings, and all the possible parameter settings. Surround modes that have no adjustable parameters are indicated as such in the description.

For explanations of the individual Surround mode parameters, refer to the “Surround Mode Parameter Descriptions” section found later in this chapter.

Logic 7 The Logic 7 mode is an advanced mode that extracts the maximum sound information from either surround-encoded programs or conventional stereo material. These surround modes can derive up to 7.1-channels of surround sound from a 2-channel or 5-channel input source. The Logic 7 mode provides full-frequency stereo surround channels that realistically increase the perceived width, length, and sense of envelopment of the listening space.

The Logic 7 mode also has additional bass-enhancement capability that circulates low frequencies in the 40Hz to 120Hz range to the front and surround speakers. This creates a soundstage that is broader and wider than when the subwoofers are the sole source of bass energy. This additional bass enhancement feature can be turned On or Off.

3-48

L7 Film (Logic 7 Film)

This Surround mode is designed for enhanced playback of 2-channel stereo, multi-channel, or matrix-encoded film sources. Use this mode with any source that contains Dolby Surround, DTS:Neo6, or similar matrix-encoding to experience increased center channel intelligibility and more accurate placement of sounds.

Parameter	Default Setting	Possible Settings
Vocal Enhance	+0.0dB	+0.0dB, +3.0dB, +6.0dB
Re-Equalizer	On	On, Off
Sound Stage	Neutral	Front, Neutral, Rear
5-Speaker Enhance	On	On, Off
Bass Enhance	Off	On, Off
Surround Roll-Off	7.0kHz	500Hz to 20.0kHz, Off
Rear Delay Offset	15ms	1ms to 30ms, Off
Compare	Default	Default, Custom

L7 TV (Logic 7 TV)

This mode is based on the L7 Film mode, but tailored specifically for broadcast sources.

Parameter	Default Setting	Possible Settings
Vocal Enhance	+0.0dB	+0.0dB, +3.0dB, +6.0dB
Front Steering	Film	Off, Music Surround, Music, Film
Re-Equalizer	Off	On, Off
Sound Stage	Rear	Front, Neutral, Rear
5-Speaker Enhance	On	On, Off
Bass Enhance	Off	On, Off
Surround Roll-Off	7.0kHz	500Hz to 20.0kHz, Off
Rear Delay Offset	15ms	1ms to 30ms, Off
Compare	Default	Default, Custom

3-49

L7 Music (Logic 7 Music)

This Surround mode is designed for enhanced playback of 2-channel stereo, multi-channel, or matrix-encoded music sources. The L7 Music mode enhances the listening experience by presenting a wider front soundstage and greater rear ambience. This mode also directs the low-frequency information to the subwoofer (if installed and configured) to deliver maximum bass impact.

Parameter	Default Setting	Possible Settings
Vocal Enhance	+0.0dB	+0.0dB, +3.0dB, +6.0dB
Front Steering	Music	Off, Music Surround, Music, Film
Sound Stage	Neutral	Front, Neutral, Rear
5-Speaker Enhance	On	On, Off
Bass Enhance	Off	On, Off
Surround Roll-Off	7.0kHz	500Hz to 20.0kHz, Off
Rear Delay Offset	15ms	1ms to 30ms, Off
Compare	Default	Default, Custom

L7 Music Surround (Logic 7 Music Surround)

This Surround mode is designed for enhanced playback of 2-channel stereo or multi-channel music sources recorded in real spaces and for playback of recordings that contain added reverb. The L7 Music Surround mode enhances the listening experience by extracting ambient sounds from the input source and sending these sounds to all speakers. Since the ambient sounds are heard from all directions, it creates a realistic playback presentation that simulates what listeners experience in real spaces.

We recommend using this mode for classical music scores, since classical music presentations are typically recorded in real spaces with additional reverb to enhance the stereo mix.

Parameter	Default Setting	Possible Settings
Vocal Enhance	+0.0dB	+0.0dB, +3.0dB, +6.0dB
Front Steering	Music Surround	Off, Music Surround, Music, Film
Sound Stage	Neutral	Front, Neutral, Rear
5-Speaker Enhance	On	On, Off
Bass Enhance	Off	On, Off
Surround Roll-Off	7.0kHz	500Hz to 20.0kHz, Off
Rear Delay Offset	15ms	1ms to 30ms, Off
Compare	Default	Default, Custom

3-50

Dolby Pro Logic®

The Dolby Pro Logic® modes are specifically designed for playback of Dolby Surround-encoded sources. The N°502 supports all extensions of the Pro Logic surround mode family.

An extension of the Dolby Pro Logic matrix technology, Dolby PLIIx dynamically creates a 7.1-channel sound field from matrix surround, 2-channel stereo, or 5.1-channel digital sources when your system is configured for surround back speakers. Dolby PLII is available for systems configured for 5.1-channel surround sound.

Note

The N°502 handles Dolby EX encoding differently. Refer to the “Audio Profiles” section found earlier in this chapter for more details.

The table below identifies the Dolby Pro Logic Surround modes available for possible selection in the N°502. These modes are only available if the listed conditions are met by the selected Activity.

Dolby Pro Logic Surround Mode	Required Conditions
Dolby Pro Logic IIx Movie	Surround AND Back speakers (7.1-channel system) must be active
Dolby Pro Logic IIx Music	Surround AND Back speakers (7.1-channel system) must be active
Dolby Pro Logic II Movie	Surround OR Back speakers (5.1-channel system) must be active
Dolby Pro Logic II Music	Surround OR Back speakers (5.1-channel system) must be active

Dolby Pro Logic IIx Movie & Dolby Pro Logic II Movie

The Dolby PLIIx Movie and Dolby PLII Movie Surround modes are optimized for the playback of film sources.

These two Surround modes have no adjustable parameters.

3-51

Dolby Pro Logic IIx Music & Dolby Pro Logic II Music

The Dolby PLIIx Music and Dolby PLII Music Surround modes are optimized for the playback of music sources.

Parameter	Default Setting	Possible Settings
Panorama	Off	On, Off
Center Width	3	Minimum, 1 to 6, Maximum
Dimension	Neutral	Front, Neutral, Rear
Surround Delay	10 ms	0 ms to 15 ms
Compare	Default	Default, Custom

Note

If the Activity is not configured for a center channel, the Center Width parameter is grayed out and not available for adjustment.

Dolby Pro Logic

The Dolby Pro Logic Surround mode is designed for playback of Dolby Surround-encoded sources. The mode decodes four channels from Dolby Surround-encoded sources and uses a mono surround channel with a high-frequency roll-off above 7kHz.

This Surround mode has no adjustable parameters.

DTS Neo:6 DTS Neo:6 modes are designed for 5-channel, 6-channel, or 7-channel surround systems.

Note The N°502 handles DTS-ES encoding differently. Refer to the “Audio Profiles” section found earlier in this chapter for more details.

DTS Neo:6 Cinema & DTS Neo:6 Music

The DTS Neo:6 modes are designed for the playback of matrix-encoded digital stereo film or music sources. The DTS Neo:6 modes derive six channels when both surround (side) and surround back (rear) speakers are present (surround back speakers are mono). It derives five channels when only surround speakers are present.

Use DTS Neo:6 Cinema when a program with any type of matrix surround encoding is present. Select DTS Neo:6 Music for optimal processing when playing a non-encoded, 2-channel stereo program material.

These two Surround modes have no adjustable parameters.

Multi-channel The Multi-channel Surround modes are provided for multi-channel input signals.

Multi-channel

The Multi-channel mode is a “pass-thru” mode, performing no processing on the input signal so it is output in its native format.

This Surround mode has no adjustable parameters.

Downmix

The Downmix mode modifies a multi-channel signal, transforming it into a 2-channel signal. The downmixed reproduction of the input signal is sent to only the front left and right speakers.

Parameter	Default Setting	Possible Settings
Surround Mix	0dB	-5dB to +5dB
Master Level	0dB	-5.0dB to +5.0dB
Compare	Default	Default, Custom

2-Channel The 2-channel Surround modes are provided for 2-channel input signals.

Stereo Surround

This mode is designed for the playback of stereo sources. The mode sends the left channel to the Front, Surround, and Back Left channels and the right channel to the Front, Surround, and Back Right channels. The Center channel is a sum of the Left and Right channels. We recommend using this mode for background music.

3-53

This mode has no adjustable parameters.

Stereo

The Stereo mode turns off all processing to present pure front left and right channel stereo programs. Bass management remains active to route the low frequencies to the subwoofers.

This mode has no adjustable parameters.

Mono The Mono modes are designed for use with monophonic recordings, although today, the only truly “mono” digital signal that still exists is Dolby Digital 1.0, a mono version of Dolby Digital. These are most commonly used for watching old movies that were originally released with mono soundtracks, such as *The Wizard of Oz* or *Casablanca*.

Mono Logic

The Mono Logic mode, designed for the playback of mono sources, uses proprietary reverb algorithms to realistically expand the mono sources to

use all available channels, including 7-channel surround systems. This dramatically increases the perceived width and sense of envelopment of the listening space as compared to the basic mono sound.

Parameter	Default Setting	Possible Settings
Effect Level	-9dB	-12dB to +6dB
Academy Filter	On	Off, On
Surround Roll-Off	3.1 kHz	500Hz to 20.0kHz, Off
Compare	Default	Default, Custom

Mono Surround

The Mono Surround mode is designed for the playback of mono sources. This mode expands the mono sources to use all available channels, including 7-channel surround systems, but does not otherwise modify the signal. The use of all speakers increases the soundstage and perceived sense of envelopment of the listening space.

This mode has no adjustable parameters.

3-54

Mono

The Mono mode is designed for the playback of mono sources and sends all audio to the center channel only. Bass management remains active to route the low frequencies to the subwoofers.

This mode has no adjustable parameters.

Show All Modes

The Show All Modes parameter, when selected, lists all available modes in the Surround Mode Adjust menu.

Hide Unused Modes

When selected, the Hide Unused Modes parameter hides all unused modes from the Surround Mode Quick Adjust menu, so that only the current mode is available.

Surround Mode Parameter Descriptions

This section provides detailed descriptions of the individual Surround Mode parameters.

5-Speaker Enhance

The 5-Speaker Enhance parameter simulates 7-channel playback in 5-channel speaker configurations. When set to On, the N°502 provides an increased sense of spaciousness and envelopment through the surround speakers. This enhancement is most noticeable when the surround speakers are positioned to the sides of the primary listening position, or when the primary listening position is located against the rear wall. The effectiveness of this parameter varies within the listening space. For best results, place the surround speakers to the left and right of the primary listening position. This parameter is available in all Logic 7 modes.

Academy Filter

The Academy Filter parameter restores the proper tonal balance of older mono film sources that have much narrower frequency responses than more recent mono film sources. This parameter is available in the Mono Logic mode.

Bass Enhance

The Bass Enhance parameter enhances the stereo bass, which results in low-frequency reproduction that is less localized and more realistic in the listening space. The effectiveness of this parameter varies depending upon the room acoustics and the ability of the surround speakers to reproduce low frequencies. For best results, use front, side, or rear speakers that are capable of reproducing frequencies of 40Hz or lower. This parameter is available in all Logic 7 modes.

Center Width

The Center Width parameter adjusts the center image.

- When set to Min, the center image is heard just from the center speaker.
- When set to Max, the center image is heard as a “phantom” center image from the front left and right speakers.
- When scaled from 1 to 6, the center image is heard in various combinations of the front and center speakers.

This parameter is available in Dolby PLIIx Music and Dolby PLII Music modes.

Compare The Compare function allows comparison listening between the factory default setting of the selected Surround mode and the customized version that you created by modifying the Surround mode parameters.

- Select the Default option to hear the Surround mode in its factory default condition.
- Select the Custom option to hear the Surround mode in its custom condition, which includes all current Surround mode parameter settings.

Keep in mind that these two settings will sound identical when all Surround Mode menu parameters are set to their factory default settings. This parameter is available in all Logic 7 modes, as well as Dolby PLIIx Music, Dolby PLII Music, Downmix, and Mono Logic modes.

Dimension The Dimension parameter controls the relative balance of the sound field, which can be useful with certain recordings to achieve more suitable balance among all speakers. This parameter is available in Dolby PLIIx Music and Dolby PLII Music modes.

- When set to Front, the sound field is balanced toward the front of the listening space.
- When set to Neutral, the sound field is balanced at the center of the listening space.
- When set to Rear, the sound field is balanced toward the rear of the listening space.

3-56

Effect Level The Effect Level parameter adjusts the amount of effect applied to the surround mode. This parameter is available in the Mono Logic mode.

Front Steering The Front Steering parameter adjusts the front steering between the front left, center, and front right speakers. Set this parameter to Film for film and broadcast sources, and to Music, Music Surround, or Off for music sources.

- When set to Film, maximum front steering is applied.
- When set to Music, moderate front steering is applied.
- When set to Music Surround, minimum front steering is applied.
- When set to Off, no front steering is applied.

This parameter is available in Logic 7 TV, Logic 7 Music, and Logic 7 Music Surround modes.

- Master Level** The Master Level parameter adjusts the output level of 2-channel sources. This parameter is available in the Downmix mode.
- Panorama** The Panorama parameter, when set to On, extends the front stereo image to include the surround channel signals, creating a “wraparound” effect with side wall imaging. This parameter is available in Dolby PLIIx Music and Dolby PLII Music modes.
- Re-Equalizer** The Re-Equalizer parameter simulates the high-frequency attenuation that occurs in movie theaters.
- When set to On, the N°502 applies a high-frequency filter.
 - When set to Off, the N°502 doesn't apply the filter.
- We recommend turning this parameter on for film sources as many films are mixed for movie theaters and might sound too “bright” when played back in your home theater without re-equalization. This parameter is available in Logic 7 Film and Logic 7 TV modes.
- Rear Delay Offset** The Rear Delay Offset parameter increases the perceived depth of the listening space by delaying the arrival time of the rear speaker signals. Increase the setting for a greater sense of depth in the listening space. This parameter is available in all Logic 7 modes.
- Sound Stage** The Sound Stage parameter dynamically controls the relative balance of the audio output connectors.
- When set to Front, the side and rear output levels are attenuated by 6dB, shifting the perceived balance of the sound field to the front of the listening space.
 - When set to Neutral, the side and rear output levels are slightly attenuated by 3dB, shifting the perceived balance of the sound field to the center of the listening space.
 - When set to Rear, the side and rear output levels are not attenuated, perserving the intended balance of the sound field.
- This parameter is available in all Logic 7 modes.
- Surround Delay** The Surround Delay parameter increases the perceived depth of the listening space by delaying the arrival time of signals from the side and rear speakers. Increase this setting when a greater sense of depth is desired in the listening space. This parameter is available in Dolby PLIIx Music and Dolby PLII Music modes.

Surround Mix The Surround Mix parameter controls the relative level of the surround channel information sent to the audio output connectors labeled Front. We recommend setting this parameter to +2dB or +3dB for all input sources. This parameter is available in the Downmix mode.

Surround Roll-Off The Surround Roll-Off parameter applies high-frequency attenuation control to the audio output connectors labeled Surround and Back. This filter is only applied to output signals generated by the N°502. This parameter is available in all Logic 7 modes and the Mono Logic mode.

Vocal Enhance The Vocal Enhance parameter controls the level of dialogue boost in the audio output connector labeled Center. Increase this setting to improve dialogue intelligibility, especially for lower volume levels. This parameter is available in all Logic 7 modes.

Name Selector

Any Display Setup, Speaker Configuration, Audio Profile, Video Profile, or Activity can have a customized name associated with it. The same interactive display screen, the Name Selector, is used for all custom naming actions. The Name Selector opens whenever the menu options Name or Add New are selected. For any custom name, a maximum limit of 13 characters is allowed.

The Name Selector has several components:

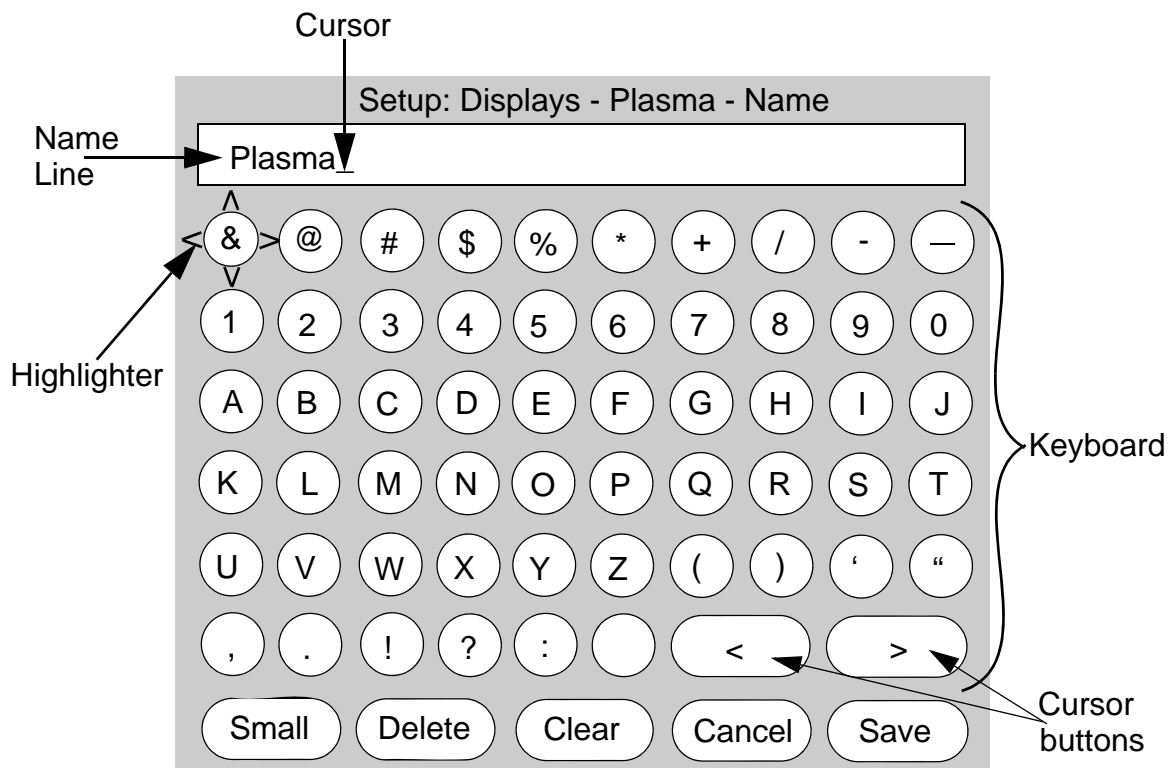

3-59

- **Name Line** – displays the name of the Activity, Profile, or Setup being modified. All edits made in the Name Selector are reflected on this line.
- **Cursor** – marks the current character position on the Name Line. The blinking Cursor can be moved to any position on the Name Line by using the Cursor buttons.
- **Cursor buttons** – Cursor moves to any position on the Name Line.
- **Keyboard** – contains selectable alphabet, number, and symbol characters. The new name is made by selecting and entering letters from the Keyboard.
- **Highlighter** – encircles and highlights any command or character on the Keyboard.
- **Small (Cap)** – toggles the Keyboard between upper-case and lower-case characters. When Small is visible, the Keyboard displays

upper-case letters; when Cap is visible, then lower-case letters are displayed.

- **Delete** – deletes the highlighted character on the Name Line.
- **Clear** – clears all of the characters on the Name Line.
- **Cancel** – exits the Name Selector without saving any changes.
- **Save** – saves the name displayed on the Name Line and exits the Name Selector.

Note

A blank name cannot be saved. The Name Line must contain at least one character in order to save the name.

Using the Name Selector to Customize a Name:

When the Name Selector first opens, in response to the Add New or Name selections, the existing or default Name is listed on the Name Line. The Cursor always defaults to end of the listed Name.

1. Use the navigation buttons on the remote control to place the Highlighter over the first letter in the new name and press the Enter button to put the highlighted letter on the Name Line at the current Cursor location.

If you are replacing an existing name, select the Clear button first to erase the existing name.

To modify an existing name, use the Cursor buttons to move the Cursor to any existing letter position or to the end of the existing name. Pressing the Delete key erases the letter in the Cursor position. Selecting a new letter on the Keyboard and then pressing Enter inserts the new letter into the Cursor position.

2. Repeat Step 1 to spell out the new name.
3. When the desired name is displayed on the Name Line, move the Highlighter to the Save button.
4. Press Enter to save the new name.

The Name Selector compares the new name to those currently in use. If the name is a repeat, the N°502 displays an error message, indicating that the entered name is already in use and prompting you to select a different name.

You have now created a custom name.

When the name is saved, the Name Selector closes and the N°502 automatically returns to the Setup menu you were in previous to selecting the Name menu option. The new name is displayed in the menu path at the top of the menu, indicating that you are now editing the new Setup, Profile, or Activity.

4

Troubleshooting & Maintenance

Incorrect operation is sometimes mistaken for malfunction. If problems occur, see this section for troubleshooting information. If problems persist, contact your authorized Mark Levinson dealer.

No Power

1. Examine the power cord to ensure that it is connected to both the rear panel connector of the N°502 and an electrical outlet.
2. Make sure the N°502 is powered on with the power button.
3. Make sure the N°502 is **not** in Standby mode (the LED should **not** be slowly blinking).
4. Examine the electrical circuit breaker to ensure that power is being supplied to the electrical outlet to which the N°502 is connected.

Remote Control Doesn't Work

1. Eliminate obstructions between the remote control IR transmitter and the front panel display IR receiver/transmitter. The remote control must be in line-of-sight with the front panel IR receiver for proper operation.
2. Replace the remote control batteries. Verify that the remote control batteries are inserted correctly with the proper polarity.
3. Make sure the IR input connector is not being used.
4. Make sure the front panel display IR receiver/transmitter is not exposed to strong sunlight, halogen light, or fluorescent light. This can cause IR reception to become unreliable. If the N°502 is placed inside a glass cabinet, tinted glass will reduce the remote control range.
5. If you have multiple Mark Levinson products, verify that you are using the proper remote control for the product in question.

4-1

No Audio Output

1. Make sure that the source device is powered on, playing audio, and set to the right output connector.
2. Make sure the master volume is set to an audible level.
3. Make sure that the volume is not muted. The LED beside the front panel Mute button should **not** be illuminated.
4. Examine audio cables to ensure a solid connection between the N°502 and associated components.

5. Make sure the N°502 main output connectors are connected to an operational power amplifier, and that the associated power amplifier is connected to operational loudspeakers.
6. Verify that the Activity has the correct input and output rear panel connections selected, as well as the correct Audio Profile. Refer to *Chapter 3: Customizing the N°502* for more information.

Audio Has a Humming Sound

1. If a cable TV connection is present, disconnect the cable from the wall outlet. If this eliminates the humming sound, a ground loop isolation device is required. Contact your dealer or cable provider for assistance.
2. Disconnect the components one at a time to isolate the problem. Once the problem is identified, make sure the associated component is properly grounded and connected to the same electrical circuit as the N°502.

Subwoofer(s) Distorts Frequently

The likely cause for the subwoofer(s) to distort is either an incorrectly set output level or the subwoofer crossover point is set too low. Refer to the “Speaker Setup” section of *Chapter 3: Customizing the N°502* for more information.

4-2

Analog Audio Sounds Distorted

1. Distorted analog audio is most likely caused by the input level of the source being too high. If the input level is too high, then signal clipping at the analog-to-digital converter occurs. This problem can be resolved by adjusting the Stereo Analog In Level parameter. Refer to the “Activities” section of *Chapter 3: Customizing the N°502* for more information.
2. If the input source has a gain control for the analog output, verify that it’s not adjusted too high.

Audio or Video RF Interference

1. Verify that the N°502 is not positioned too close to RF-emitting devices. Move such items one at a time to isolate which device is causing the problem.
2. Replace unshielded cables with shielded cables wherever possible.

Volume Can’t Be Set to Maximum

The user has the option of manually setting a maximum volume level. If set, this will prevent the maximum specified volume level of the N°502 from being reached. Refer to the “User Options” section of *Chapter 3: Customizing the N°502* for more information.

Front Panel Display Not Working

1. Verify that the front panel display has not been deactivated. Verify that the Display Intensity parameter in the Setup:User Options-Display Options menu is NOT set to Off.

2. Verify that the Monitor Output is not active. Connect a monitor to the Monitor Out connector on the rear panel of the N°502. If the monitor displays an image matching the Main Zone display image, then the Monitor Output is active. Refer to the “Rear Panel Overview” section of *Chapter 2: Basic Operation* for more information.

No Video Output

1. Make sure that the source device is powered on, playing video, and set to the right output connector.
2. Examine the video cables to ensure a good connection to the associated component.
3. Verify that the selected output is not analog with an HDCP (High-Bandwidth Digital Content Protection) input source. Source material that carries HDCP-encoding is only available through the HDMI output. No video is output on the analog output connectors.
4. Verify that the cable connections between the N°502 rear panel connectors and the other components are correct.
5. Verify that the Activity has the correct input and output rear panel connections selected, as well as the correct Video Profile and Display Setup. Refer to *Chapter 3: Customizing the N°502* for more information.

Video Format Problems on Fullscreen Display

Video format problems while using a fullscreen display (4:3 aspect ratio) are typically due to incompatible or conflicting settings between the incoming source, the display setup, and the N°502 video format settings. Examples of these errors include:

- Extra pillarboxing (wider than normal black bars on the left & right sides) and horizontal stretching, so that people appear tall & thin, caused by incorrect settings on the source.
- Black bars on the top & bottom and the left & right sides of the image due to an incorrect aspect ratio setting on the N°502 Media Console.
- Black bars on all sides and vertical squashing, so that people appear short & fat, caused by incorrect settings on the source.

Refer to the “Troubleshooting Display Formats” section found later in this chapter for possible solutions to these errors.

Video is Behaving Oddly With HDMI Connections

Connecting together all of the components of your home theater system with HDMI connectors requires every piece of equipment in the signal chain to communicate its capabilities and requirements with respect to the video stream and possible HDCP encryption. If any piece is not communicating properly, then odd results can occur. For example, if the timing of the communication is off, it might cause incorrect colors to appear on the screen, or to shift all of the video to the left or toward the top of the screen. If the video monitor doesn't communicate properly, it might load the color spacing incorrectly so that the screen appears to be all one color, instead of displaying normal color.

To correct the problem, the system communication needs to be realigned, which should clear the error. Some issues are easier to clear than others. Typically power cycling the N°502 will clear it, but some issues don't need a power cycle. We suggest you try the following:

1. Verify the HDMI cables have a good connection with the rear panel connectors.
2. Put the N°502 into Standby mode. Wait 10 seconds. Then take the N°502 out of Standby mode.
3. Power cycle the N°502 by turning off the power switch; wait at least 10 seconds, and then turn the power switch to the On position. Then take the N°502 out of Standby mode.
4. With the N°502 turned off, power cycle all other devices that are connected to the N°502, such as DVD and CD players, projectors, and monitors. When finished turning all other devices back on, restore power to the N°502 and take it out of Standby mode.

Link2 Not Working

1. Verify that the N°502 and the amplifiers are daisy-chained properly. Refer to the "Link2" section of the *Appendix* to verify proper setup.
2. Refer to the product documentation of each amplifier to verify compatibility and the proper cabling.
3. Power down all of the devices, then power up the N°502, followed by each amplifier. Allow each device to go through its initialization process before powering up the next device. The Standby LEDs should now be blinking in unison.

4-4

Can't Assign a Slave in ML Net

You must assign the slave from the Master. Press the Setup button the N°502 and select User Options. Then select Control Options:ML Net:ML Net Setup. Verify that the Slave you want to Assign is in the device list and check its current state.

If the current state is assigned, then you must first unassign it from the ML Net system. Once a Slave is assigned, it will not accept another assignment until it has first been unassigned. Once the device is unassigned, you can then reassign it to the desired ML Net system.

For explanations about other current states, refer to the "ML Net" section of *Chapter 3: Customizing the N°502*.

Configuration Download Not Working

If you are having difficulty with the Configuration Download, the issue may be related to the Network Setup of either the N°502, the Ethernet connection, or the setup of the connected computer.

1. Verify that the proxy server in the computer's network setup is disabled. An active proxy server can interfere with the configuration download procedure.

2. If the web browser cannot find the Host Name of the N°502, verify the following:
 - Ensure that the local DNS server is properly configured. We recommend configuring the local DNS Server to “DNS Forwarding” mode. To configure the DNS Server, refer to the setup manual of the server.
 - When using a subdomain, enter the complete address into the browser, *http://ML502.yourhome.network.com* - where ML502 is the default Host Name for the N°502 and yourhome is a subdomain in the local network.
 - Enter the IP Address of the N°502 into the browser, for example, *http://192.168.50.2* - to find the correct address, refer to Auto IP Address in the Setup>User Options-Control Options-Network Setup menu.
3. Verify that the N°502 and computer are connected properly. Connecting the N°502 and computer together without a router requires a special type of network cable. Refer to the “Saving the N°502 Configuration” section of the *Appendix* for more details.

No Connectivity Via Ethernet

- Verify that the network cables are properly connected between the router, switch, or hub and the N°502. If connecting to a computer, verify that the computer network cable is in the correct port.
- Verify the age of the router, switch, or hub. If the router, switch, or hub is more than ten years old, there may be a communication issue with the N°502. Power cycle the N°502 and use a newer router, switch, or hub between the network and the N°502.

4-5

If All Else Fails...

1. Power cycle the N°502, waiting at least 10 seconds between powering the N°502 off and on.
2. Download the N°502 configuration and then restore the factory default settings. See the “Restoring Factory Default Settings” section found later in this chapter.
3. Contact an authorized Mark Levinson dealer.
4. Contact Mark Levinson Customer Service at 781-280-0300 or www.marklevinson.com.

Automatic Calibration Errors

During the Automatic Calibration, errors that may occur are reported at two points – after the Check Microphones test and after the Run Automatic Calibration procedure. When the two routines are run, any errors are logged and then reported when the procedure is complete.

The tables below include listings of the possible errors, the description of each error, and troubleshooting information for resolving the errors.

Check Microphones Test Refer to the table below for information about errors occurring during the Check Microphones Test.

MESSAGE	DESCRIPTION	TROUBLESHOOTING
(microphone) OK	The microphone detected the calibration noise signal without error.	N/A
(microphone) NOT DETECTED	The N°502 did not detect the microphone during the silence check.	<ul style="list-style-type: none"> Examine the microphone input connections to ensure that the microphones are properly connected to the N°502 and that the microphone cable plugs are fully inserted for a solid connection. The microphone might be damaged. Contact an authorized Mark Levinson dealer for assistance.
(microphone) SIGNAL TOO LOW	The N°502 detected the microphone during the silence check. However, the microphone level determined during the silence check was not confirmed during the microphone check.	<ul style="list-style-type: none"> Examine the microphone input connections to ensure that the microphones are properly connected to the N°502 and that the microphone cable plugs are fully inserted for a solid connection. The microphones might be positioned too far from the front speakers. Refer to the microphone placement examples in Chapter 3 to confirm that the microphones are appropriately positioned for the microphone check. The microphone might be damaged. Contact an authorized Mark Levinson dealer for assistance.
(microphone) OUT OF RANGE	The microphone level is more than 20dB below the highest microphone level.	<ul style="list-style-type: none"> The microphone might be damaged. Contact an authorized Mark Levinson dealer for assistance.
(microphone) TOO MUCH ROOM NOISE	The microphone level could not be determined because of excessive room noise in the listening space.	<ul style="list-style-type: none"> Eliminate extraneous noises in the listening space, including conversations, air conditioners, and sounds that filter in through open doors and windows. The microphone might be damaged. Contact an authorized Mark Levinson dealer for assistance.

Run Automatic Calibration Refer to the table below for information about errors occurring during the Run Automatic Calibration procedure.

ERROR MESSAGE	DESCRIPTION	TROUBLESHOOTING
(speaker) SPEAKER IS NOT ENABLED	The selected speaker is not present in the speaker setup.	<ul style="list-style-type: none"> Return to the Speaker Setup menu and verify that the speaker has been activated. The parameter value must be Yes to be active.
(speaker) SPEAKER IS OUT OF PHASE	The microphones detected out-of-phase calibration noise signals, but the calibrated value is still accurate.	<ul style="list-style-type: none"> Examine the speaker/associated amplifier connections to ensure that the speaker wires are not crossed. Dipolar speakers could cause this error. However, the N°502 does not report this error unless at least half of the microphones detect out-of-phase calibration noise signals. Reflections from room objects can cause an out-of-phase error. Drivers intentionally wired out-of-phase can cause an out-of-phase error.
(speaker) SIGNAL TOO LOW	The microphones detected calibration noise signals at an unusually low level.	<ul style="list-style-type: none"> The microphones might be positioned more than 30 feet (9.14m) from the selected speaker or in a location where echoes obscure calibration noise signals. Refer to the placement examples discussed in Chapter 3 to confirm that the microphones are appropriately positioned for automatic calibration. Examine the microphone input connections to ensure that the microphones are properly connected to the N°502 and that the microphone cable plugs are fully inserted for a solid connection.
(speaker) UNABLE TO CALCULATE	The microphones did not detect calibration noise signals or the N°502 could not calculate a value.	<ul style="list-style-type: none"> Refer to the placement examples discussed in Chapter 3 to confirm that the microphones are appropriately positioned for automatic calibration. Examine the microphone input connections to ensure that the microphones are properly connected to the N°502 and that the microphone cable plugs are fully inserted for a solid connection.
(speaker) MAY NOT BE ACCURATE	One or more microphones did not detect calibration noise signals at a reasonable level. The calibrated value could be inaccurate.	<ul style="list-style-type: none"> Refer to the placement examples discussed in Chapter 3 to confirm that the microphones are appropriately positioned for automatic calibration.
(speaker) SPEAKER OUTPUT TOO HIGH (only affects the Speaker Levels calibration)	The microphones detected calibration noise signals at an unusually high level.	<ul style="list-style-type: none"> Decrease the associated amplifier volume levels – including powered subwoofer amplifiers, if applicable. The microphone may be positioned too close, within 2 feet (0.61m), to the selected speaker. Refer to the placement examples discussed in Chapter 3 to confirm that the microphones are appropriately positioned for automatic calibration.
(speaker) SPEAKER OUTPUT TOO LOW (only affects the Speaker Levels calibration)	The microphones detected calibration noise signals at an unusually low level.	<ul style="list-style-type: none"> Increase the associated amplifier volume levels - including powered subwoofer amplifiers, if applicable. The microphone may be positioned too far away, more than 30 feet (9.14m), from the selected speaker. Refer to the placement examples previously discussed to confirm that the microphones are appropriately positioned for automatic calibration.

Error Messages

The N°502 Media Console displays error messages on the front panel and main displays when certain error conditions exist. This section provides a description of each error message and its resolution.

The displayed error message can be cleared by pressing any button or rotating one of the front panel knobs.

For information about ML Net-specific error messages, refer to the “ML Net” section of *Chapter 3: Customizing the N°502*.

Note

Some error messages close automatically while some may need to be closed. Any button press or knob turn clears the message.

Error Log

The Error Log page is part of the N°502 Internal Web Pages and can only be viewed when the N°502 is connected to a computer. The Error Log page is a diagnostic tool used by Mark Levinson Customer Service.

4-8

Audio Adjust Locked

This message displays when a locked parameter is accessed through a remote function key. To access the parameter, the lock needs to be removed. Go to the Setup:User Options-Lock Options menu to remove the lock.

Fixed Volume Mode is Active

This message displays when attempting to change the Remote Zone volume when the Remote Zone volume has been set to Fixed. The Fixed option sets the volume at 85.5 and is not adjustable. In order to change the volume level in this condition, the Remote Zone Volume parameter needs to be changed from Fixed to Variable.

Function Key is Unassigned

This message displays when a remote control function key is pressed that has no action assigned to it. To assign a specific menu parameter to an unassigned function key, go to the Setup:User Options – Control Options menu.

Name is Already in Use

This error message displays when a name is chosen in the Name Selector that is already saved. Even if the new name is for a different Activity, Profile, or Setup, every name MUST be unique.

To correct the problem, select and save a different name.

Please Save with New Name	<p>This error message displays when the Save button is pressed in the Name Selector, but the Name Line is blank. The Name Selector will not perform the Save function when the Name Line is blank.</p> <p>To correct the problem, enter a name onto the Name Line before selecting the Save button.</p>
Power Failure	<p>If the N°502 experiences a power failure condition, the front panel LEDs indicate the failure upon power up. When the N°502 is able to power up, the LEDs flash continuously between Off and full bright, regardless of the Display Intensity setting.</p>
Room Correction is Not Available	<p>This error message displays when the Room Correction control is accessed and the N°502 has not yet been calibrated. The Room Correction control cannot be activated until the Automatic Calibration has been successfully completed.</p> <p>To correct the problem, perform the Automatic Calibration.</p>
Room Correction Adjust is Not Available	<p>This error message displays when the Room Correction Adjust control is accessed and the N°502 has not yet been calibrated. The Room Correction Adjust control cannot be activated until the Automatic Calibration has been successfully completed.</p> <p>To correct the problem, perform the Automatic Calibration.</p>
Note	<hr/> <p>The Room Correction Adjust parameter is also not available when the Room Correction parameter is set to No. However, this condition does not prompt an error message.</p> <hr/>
Setup Locked/ Surround Locked	<p>This message displays when a locked parameter is accessed through a remote function key. To access the parameter, the lock needs to be removed. Go to the Setup:User Options-Lock Options menu to remove the lock.</p>
Speaker Not Available	<p>This message displays when a speaker Offset parameter is accessed that is not part of the current Speaker Setup. The speaker Offset adjustments can only be made to speakers that exist in the current Speaker Setup.</p>

Surround Mode Not Available

This error message results from the improper selection of a surround mode through the remote control Function keys. Input sources and Speaker Setups do not always support every surround mode option. Since the N°502 dynamically builds the Surround mode selection list based upon the input source and speaker configuration, this problem only results from the direct access and selection of a specific Surround mode by use of the remote control Function keys.

The following table identifies the Surround mode selection that can cause this error condition and the resolution options for each error.

4-10

Mode Selection Error	Resolution
Multi-Channel with Dolby Digital Surround EX surround back processing	This mode option is NOT compatible with the current input source. <ul style="list-style-type: none"> • Choose a different Surround Back processing option compatible with the current input source. • Select a different mode that is compatible with the current input source.
Dolby Digital PLIIx Movie Dolby Digital PLIIx Music	This mode is NOT compatible with the current input source. <ul style="list-style-type: none"> • Choose a different surround mode option compatible with the current input source. • Select an input source that is formatted for Dolby Digital PLIIx modes.
Dolby Digital PLII Movie Dolby Digital PLII Music	This mode is NOT compatible with the current input source. <ul style="list-style-type: none"> • Choose a different surround mode option compatible with the current input source. • Select an input source that is formatted for Dolby Digital PLII modes.
Multi-Channel with DTS-ES surround back processing	This mode is NOT compatible with the current input source. <ul style="list-style-type: none"> • Choose a different surround mode option compatible with the current input source. • Select an input source that is formatted for DTS modes.
DTS Neo:6 Cinema DTS Neo:6 Music	This mode is NOT compatible with the current input source. <ul style="list-style-type: none"> • Choose a Surround mode that is compatible with the current input • Select a different input source that is compatible with DTS Neo:6 Cinema or DTS Neo:6 Music mode.

Troubleshooting Display Formats

The video format is directly affected by a number of different variables, causing a wide range of potential format problems between the input source and the main display. This guide identifies common format issues and suggests possible resolutions.

Note

This guide assumes that the system you are troubleshooting uses a Widescreen display.

There are four main places where the video format is directly impacted:

- **Input Source** – the incoming video format has a fixed aspect ratio and resolution that may not be suitable to the main display.
- **Media Player** – most DVD players provide a few different aspect ratios and zoom options.
- **Display Screen** – most displays have a variety of resolution settings, although the aspect ratio is typically fixed.
- **N°502 Media Console** – the N°502 provides different aspect ratio settings, resolution formats, and zoom settings, which can alter the displayed video output.

4-11

For optimal results, make adjustments to the source video through the N°502 Media Console to take advantage of its superior video processing capabilities.

To help minimize the variables that can affect the display format, verify the following setup conditions before you start troubleshooting:

- Verify that the display and DVD player are set to a generic, normal, or standard setting that does not add any formatting to the displayed image. This minimizes the amount of formatting that the DVD player and the display add to the source image and simplifies potential troubleshooting.
- Verify that all zoom modes on the N°502, display, and DVD player are set to Normal mode.

Note

When the input format is DVI or analog, the input resolution is 480i or 480p, and the input source is a fullscreen or letterbox DVD, in order to view the image correctly the DVD player must be set to a mode that adds the black bars on the left & right sides of the image and the N°502 must be set to a 16:9 aspect ratio.





To use the troubleshooting tables:





1. Find the table with the same Input Source as you are using.
2. Use the Symptoms and Output descriptions to identify the format issue you are troubleshooting.
3. Use the Possible Solution descriptions to identify and solve the format issue.



Note

The Front Panel Display of the N°502 does not reflect display format issues. Therefore, if the Main Zone display has a formatting issue and the N°502 front panel display does not show the same issue, the problem must lie with the setup of the Main Zone display.

4-12

Input Source	Symptoms	Output	Possible Solutions
DVD Format		Output on Display	
Widescreen Anamorphic (16:9)	<ul style="list-style-type: none"> • Image fills the screen • Image is not stretched or squashed • No black bars 		<ul style="list-style-type: none"> • This is a correct image. All format settings are correct as set. • The black bars (letterboxing) are part of the DVD image. In most cases, the black bars are included on these DVDs because the original movie was filmed in a wider widescreen format than the 16:9 aspect ratio displays available for home theater system.
	<ul style="list-style-type: none"> • Image is not stretched or squashed • Image has small black bars on the top & bottom (letterboxing) 		<ul style="list-style-type: none"> • The first Output image is typical of a 16:9 aspect ratio; the second Output image is typical of aspect ratios greater than 16:9.
	<ul style="list-style-type: none"> • Image is squashed vertically, so that people appear short & fat • Image has too much letterboxing on the top & bottom 		<ul style="list-style-type: none"> • This image is NOT formatted correctly. • The DVD player may be set to the wrong aspect ratio. • The N°502 may be set to the wrong display format.
	<ul style="list-style-type: none"> • Image has black bars on the left & right sides (pillarboxing) • Image is stretched horizontally, so that people appear tall & thin 		<ul style="list-style-type: none"> • This image is NOT formatted correctly. On a widescreen source, there should NEVER be black bars on the left & right sides. • The display may be incorrectly set. If the display settings are the issue, the front panel display of the N°502 should be showing a correct image. • It's normal for widescreen aspect ratios that are less than 16:9 to have some pillarboxing.
	<ul style="list-style-type: none"> • Image has black bars on the left & right sides (pillarboxing) • Image is NOT distorted 		<ul style="list-style-type: none"> • This image is NOT formatted correctly. On a widescreen movie, there should NEVER be black bars on the right & left sides. • The display may be incorrectly set. If the display settings are the issue, the front panel display of the N°502 should be showing a correct image. • The N°502 may be set to the wrong aspect ratio. • It's normal for widescreen aspect ratios that are less than 16:9 to have some pillarboxing.

Input Source DVD Format	Symptoms	Output	Possible Solutions
		Output on Display	
Fullscreen (4:3) (typically TV shows or movies converted for TV)	<ul style="list-style-type: none"> Black bars on the left & right sides (pillarboxing) Image is not stretched or squashed Image is complete, no cropping at the sides or top/bottom 		<ul style="list-style-type: none"> This is a correct image. All format settings are correct as set. The black bars (pillarboxing) are added by the display because there is literally more display than image area available.
	<ul style="list-style-type: none"> Image is stretched horizontally, so that people appear tall & thin Image has too much pillarboxing on the right & left sides 		<ul style="list-style-type: none"> This image is NOT formatted correctly. For a fullscreen source, the left & right bars should ALWAYS be present and the image should not be distorted. The display may be incorrectly set.
	<ul style="list-style-type: none"> Image fills the screen, but some of the image is cropped or missing No black bars on the left & right sides 		<ul style="list-style-type: none"> This image is NOT formatted correctly. A stretch mode or zoom mode may be set on either the display, DVD player, or N°502 setup. Verify all stretch and zoom modes are set to normal.
	<ul style="list-style-type: none"> Image has black bars on the top & bottom (letterboxing) Image is squashed vertically, so that people appear short & fat 		<ul style="list-style-type: none"> This image is NOT formatted correctly. On a fullscreen source, there should NEVER be black bars on the top & bottom. The display may be set to the wrong aspect ratio. The N°502 may be set to the wrong display format.

Input Source DVD Format	Symptoms	Output	Possible Solutions
		Output on Display	
Letterbox Non-Anamorphic (typically older or low-budget widescreen movie)	<ul style="list-style-type: none"> Image fills the screen Image is not stretched or squashed Image has black bars on top & bottom and left & right sides 		<ul style="list-style-type: none"> This is a correct image. All format settings are correct as set. The black bars on the top & bottom (letterboxing) are part of the DVD image. The black bars on the left & right sides (pillarboxing) are added by the display because the source is a full-screen format In this case, a Zoom mode could be used to fill the screen to remove the black bars without distorting the image
	<ul style="list-style-type: none"> Image is stretched horizontally, making people appear tall & thin, or squashed vertically, making people appear short & fat Image has too much letterboxing or pillarboxing 		<ul style="list-style-type: none"> This image is NOT formatted correctly. A stretch mode or zoom mode may be set on either the display, DVD player, or N°502 setup. Verify that all stretch and zoom modes are disabled.

Restoring Factory Default Settings

Restoring the factory default settings erases all calibration and user modifications to the N°502 and returns it to the original factory settings. ***This is not a recoverable action – once the factory settings have been restored, all previous settings and calibration values are permanently erased.***

To save the configuration of the N°502, refer to the “Saving the N°502 Configuration” section in the *Appendix* before performing the procedure below.

Note All parameter default settings are identified in the Menu Trees, which can be found in the *Appendix*.

To restore factory default settings:

1. Press the Setup button.
2. Select User Options and press Enter.
3. Select Restore Options and press Enter.

A message displays asking if you are sure you want to restore the factory default settings.

4. Select Restore and press the Enter button.

The message “Factory Defaults Restored” is displayed on the front panel and main display when the factory settings have been restored.

Note The factory defaults can also be restored through the Internal Web Pages, if a computer is connected via the Ethernet port. Refer to the end of the “Saving the N°502 Configuration” procedure in the *Appendix* for more information.

Care & Maintenance

The N°502 requires routine care and maintenance to ensure optimal performance. The bulleted items indicate maintenance procedures that should be performed on a regular basis.

Note

Failure to perform the maintenance procedures included in this section may void the manufacturer's warranty and/or standard repair policies.

- To remove dust from the N°502 exterior surface, use a feather duster or a low-pressure blower.
- To remove dirt and fingerprints from the N°502 exterior surface, use a soft, lint-free cloth. DO NOT use metal polish or a cloth made with steel wool.

If needed, this cloth can be dampened with isopropyl alcohol. DO NOT dampen the cloth with Benzene, acetone-based cleaners, or other commercial cleaners.

Wipe the N°502 exterior surface in the same direction as the grain of the brushed aluminum.

Caution!

DO NOT apply liquid directly to the N°502 exterior surface. Doing so may damage electrical components.

- Replace the remote control batteries as needed.

Refer to *Chapter 1: Getting Started* for instructions on how to replace the remote control batteries.

Specifications

All specifications are subject to change without notice.

Inputs

HDMI Six HDMI Type A, Version 1.1, 19-pin connectors

Analog Video

- Four component video – one BNC & three RCA connectors (Y, Pb, Pr)
- Three S-video connectors
- Three composite video, RCA connectors

Digital Audio

- Six S/PDIF coaxial (RCA) and three S/PDIF optical (TOSlink) connectors
- Coaxial and optical input connectors conform to IEC-958, S/PDIF standards
- Two AES/EBU inputs, XLR connectors

Analog Audio

- One unbalanced 8-channel input array, RCA connectors
- Four unbalanced stereo pairs, RCA connectors
- Two balanced stereo pairs, XLR connectors
- Four microphone inputs, 3.5mm mini plug, accepts either stereo plug (tip/ring/sleeve) or mono plug (tip/sleeve)

A-1

Control Inputs & Outputs

- One RS-232 port, RJ-11 connector
- One Ethernet port, RJ-45 connector
- One Link port, RJ-45 connector
- Four programmable trigger outputs, 3.5mm mini plug, accepts either stereo plug (tip/ring/sleeve) or mono plug (tip/sleeve)
 - Output Voltage: 12V
 - Output Current: 100mA
- One IR receiver, on front panel
- One IR Input jack, 3.5mm mini plug, accepts either stereo plug (tip/ring/sleeve) or mono plug (tip/sleeve), 12V

Outputs

HDMI	Two HDMI Type A, Version 1.1, 19-pin connectors
Analog Video	<ul style="list-style-type: none"> • One component with three BNC connectors (Y, Pb, Pr) • One composite monitor, RCA connector
Analog Audio	<ul style="list-style-type: none"> • One unbalanced 7.4-channel array, RCA connectors • One balanced 7.4-channel array, XLR connectors
Remote Zone	One unbalanced stereo pair, RCA connectors

HDMI Formats

HDMI Input	Video: 480/576i, 480/576p, 720p, 1080i, 1080p Audio: Dolby Digital, DTS, and PCM (32, 44.1, 48, 88.2, 96, 176.4, and 192kHz)
HDMI Output	Video: 480/576i, 480/576p, 720p, 1080i, 1080p Audio: Dolby Digital, DTS, and PCM (32, 44.1, 48, 88.2, 96, 176.4, and 192kHz)

Component Video Performance

A-2

Compatibility	480/576i, 480/576p, 720p, 1080i
A/D Conversion	12-bit, 110MHz (4x SD, 2x ED, 1x HD oversampling)
D/A Conversion	14-bit, oversampling to 216MHz
Input/Output Levels	Y: $1.0V_{p-p}$ with 75Ω load ($700mV_{p-p}$ video) Pb/Pr: $\pm 350mV$ with 75Ω load ($700mV_{p-p}$)

S-Video and Composite Video Performance

Compatibility	NTSC/PAL
A/D Conversion	12-bit, 110MHz (4x SD, 2x ED, 1x HD oversampling)
Composite Input Level	$1.0V_{p-p}$ with 75Ω load
S-Video Input Level	Y (Luma): $1.0V_{p-p}$ with 75Ω load ($700mV_{p-p}$ video) C (Chroma): $300mV_{p-p}$ with 75Ω load
Composite Monitor Output Level	$1.0V_{p-p}$ with 75Ω load

Audio Performance

Frequency Response	20Hz to 20kHz, +/- 0.1dB
Digital Audio Sample Rates	32, 44.1, 48, 88.2, 96, 176.4, & 192kHz
A/D Conversion	24-bit/192kHz, PCM Multibit $\Sigma\Delta$
D/A Conversion	24-bit/192kHz, PCM Multibit $\Sigma\Delta$
Input Impedance	100K Ω
THD + N	94dB (Reference level: 1kHz, 30kHz LPF)
Signal-to-Noise Ratio	94dB (Reference level: 30kHz LPF)
Dynamic Range	94dB (Reference level: 1kHz, 30kHz LPF)
Maximum Input Level	7.5V/15Vrms RCA/XLR
Maximum Output Level	7.5V/15Vrms RCA/XLR
Reference Input Level	2Vrms
Reference Output Level	1.5V/3Vrms RCA/XLR

A-3

General

Power Requirements	120V~, 60Hz / 100/220/230V~, 50-60Hz; factory set for destination country
Power Consumption	175W
Dimensions	<ul style="list-style-type: none"> • Height (with feet): 9.46 inches (240.4mm) • Height (without feet): 8.70 inches (221.0mm) • Width: 17.48 inches (444.0mm) • Depth: 17.4 inches (442.4mm) • <i>See Product Dimensions diagram on the following page</i>
Weight	<ul style="list-style-type: none"> • Net weight: 54.5 lbs (24.6kg) • Shipping weight: 71.0 lbs (32.5kg)
Operating Environment	<ul style="list-style-type: none"> • Operating temperature: 0° to 35°C (32° to 95°F) • Storage temperature: -30° to 75°C (-22° to 167°F) • Relative humidity: 95% maximum without condensation
Rack Mounting	Optional Rack Mount Kit is available, refer to <i>Chapter 1: Getting Started</i> for ordering details
Remote Control	Handheld, back-lit IR operation; requires two AAA batteries (included)

N^o502 Media Console Dimensions

The diagram below provides detailed dimensions for the N^o502 Media Console. The views included are the left side, top, and front.

A-4

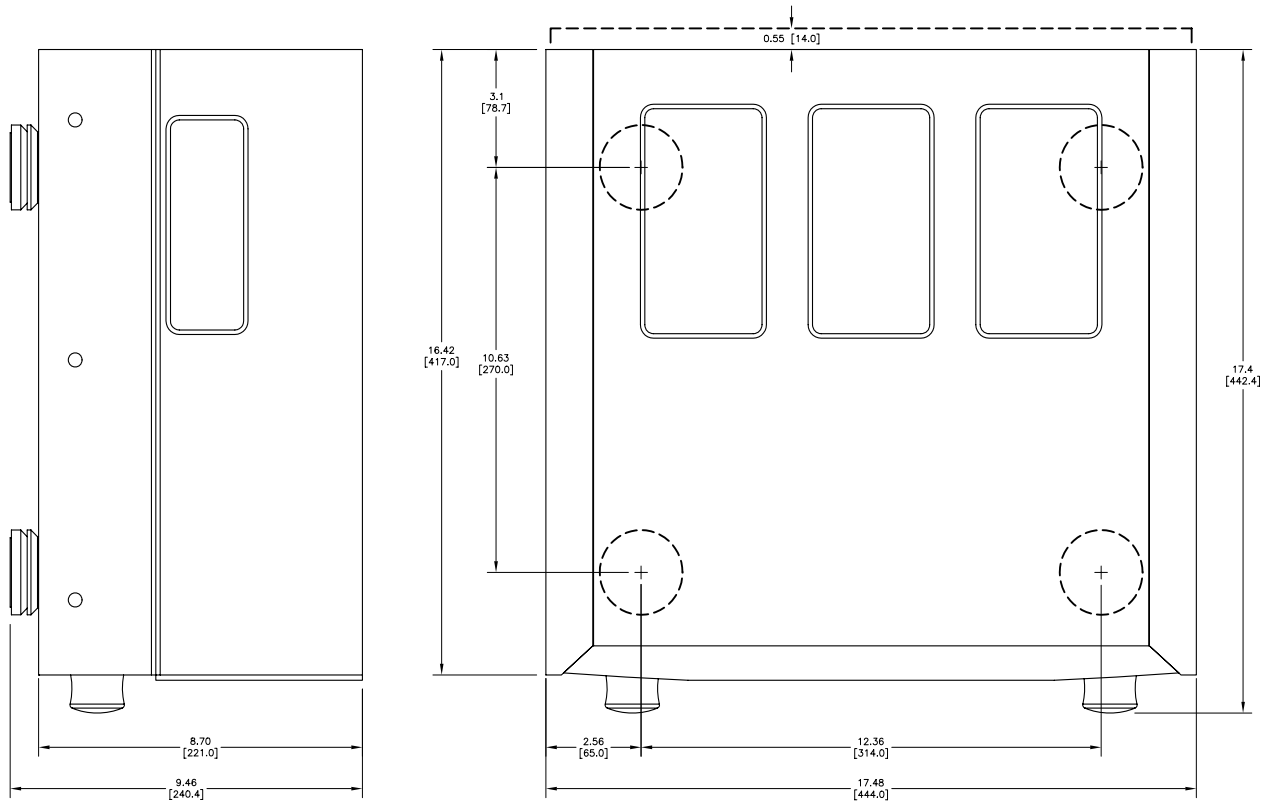

INCHES
[MM]

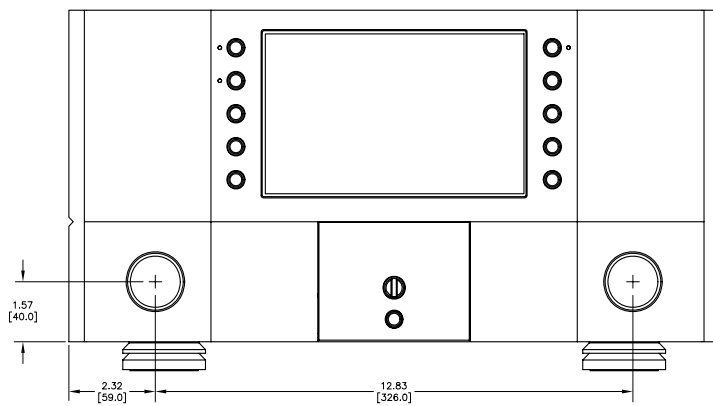

Declaration of Conformity

Application of Council Directive(s):

2004/108/EC and 2006/95/EC, as amended.

Standard(s) to Which Conformity Is Declared:

EN 55013:2001 + A1:2003 + A2:2006
EN 55020:2007
EN 61000-3-2:2006
EN 61000-3-3:1995 + A1:2001 + A2:2005
EN 60065:2002

Manufacturer: Harman Specialty Group
3 Oak Park Drive
Bedford, MA 01730-1413

The equipment identified here conforms to the Directive(s) and Standard(s) specified above.

Type of Equipment: Media Console
Models: Mark Levinson No. 502
Date: February 2008

A-5

Harman Specialty Group
Vice President of Engineering
3 Oak Park Drive
Bedford, MA 01730-1413 USA
Tel: 781-280-0300
Fax: 781-280-0490

Rack Mount Kit Instructions

Follow these instructions to install the N°502 Media Console into the optional rack mount. To order a rack mount kit, contact an authorized Mark Levinson dealer for availability and pricing.

1. Using a Phillips head screwdriver, install the rack shelf to the rack using four of the screws included in the rack mount kit.

Note

Be sure to tighten all screws so that they fit firmly. Ensure that you do NOT overtighten the screws. Overtightening the screws may strip the threads, thereby making the connection not secure.

2. Slide the N°502 Media Console onto the rack shelf until the front panel is flush with the edges of the rack.
3. Position one of the dress plates included with the rack mount kit across the top of the N°502 and screw to the rack using two of the screws from the kit.
4. Position the second dress plate across the bottom of the N°502 and screw to the rack using the last two screws from the kit.

You have now completed the rack shelf installation. The finished assembly occupies six rack units. The slots in the rear of the rack shelf are designed for cable management.

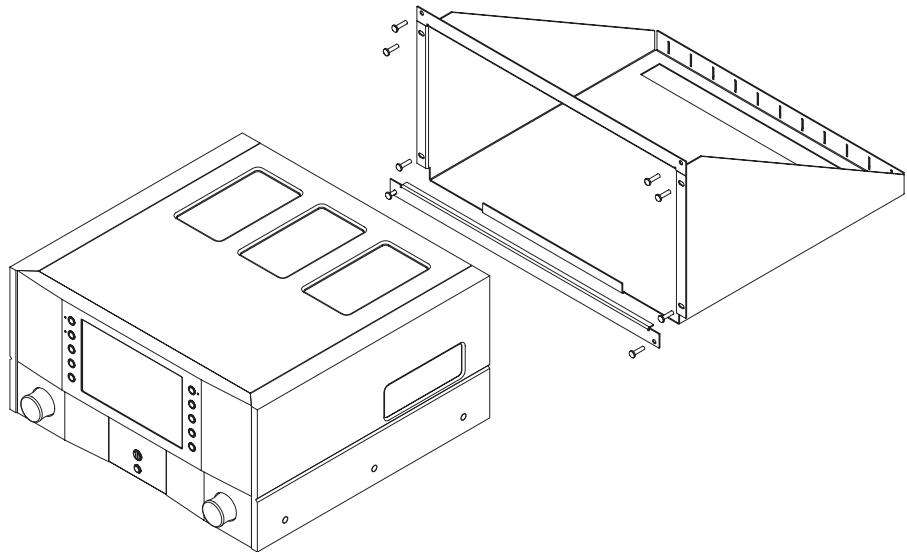

Activity Menu & Zone Menu Trees

NOTE: All defaults appear in bold.

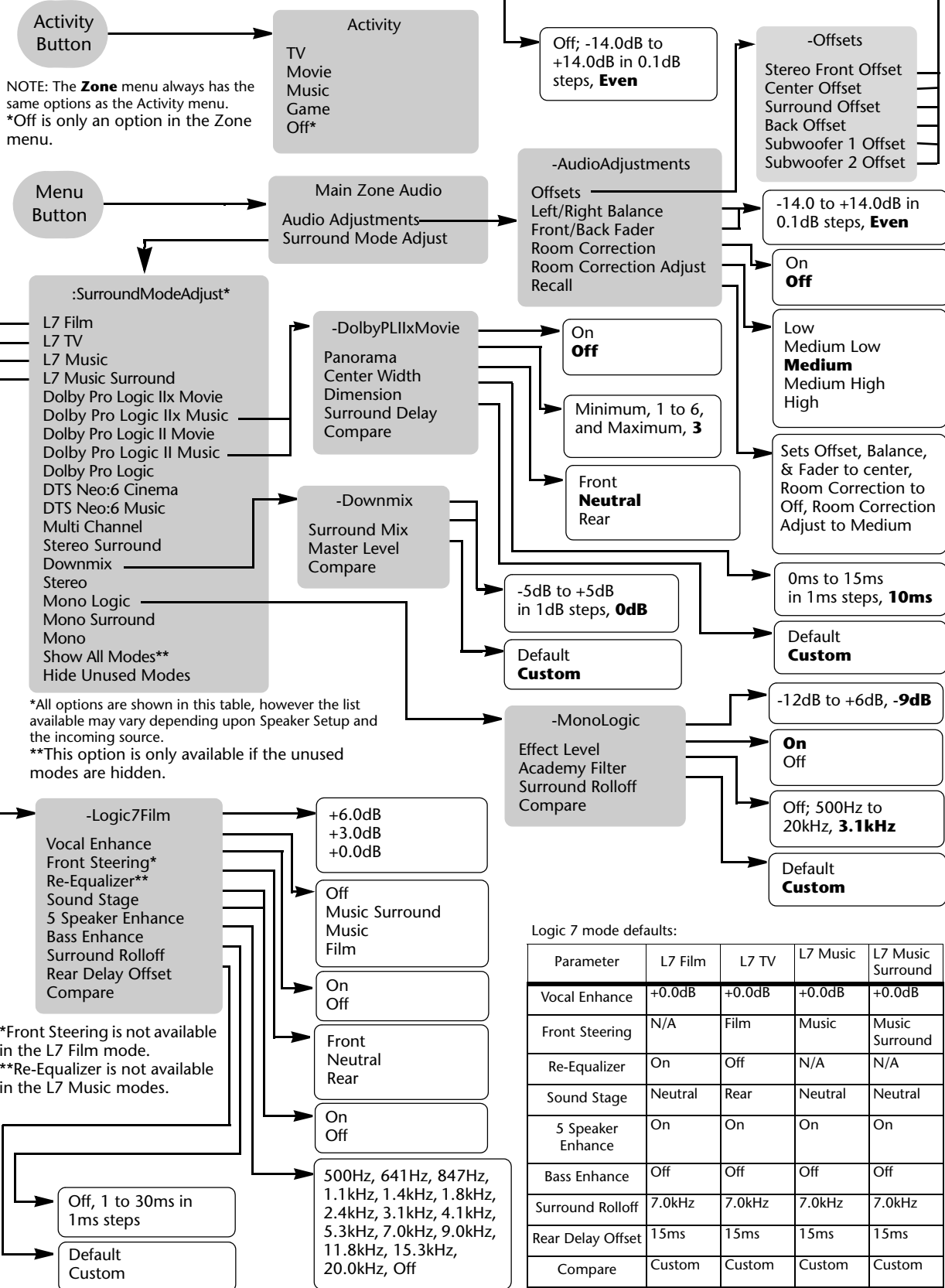

Display Setup & Video Profile Setup Menu Trees

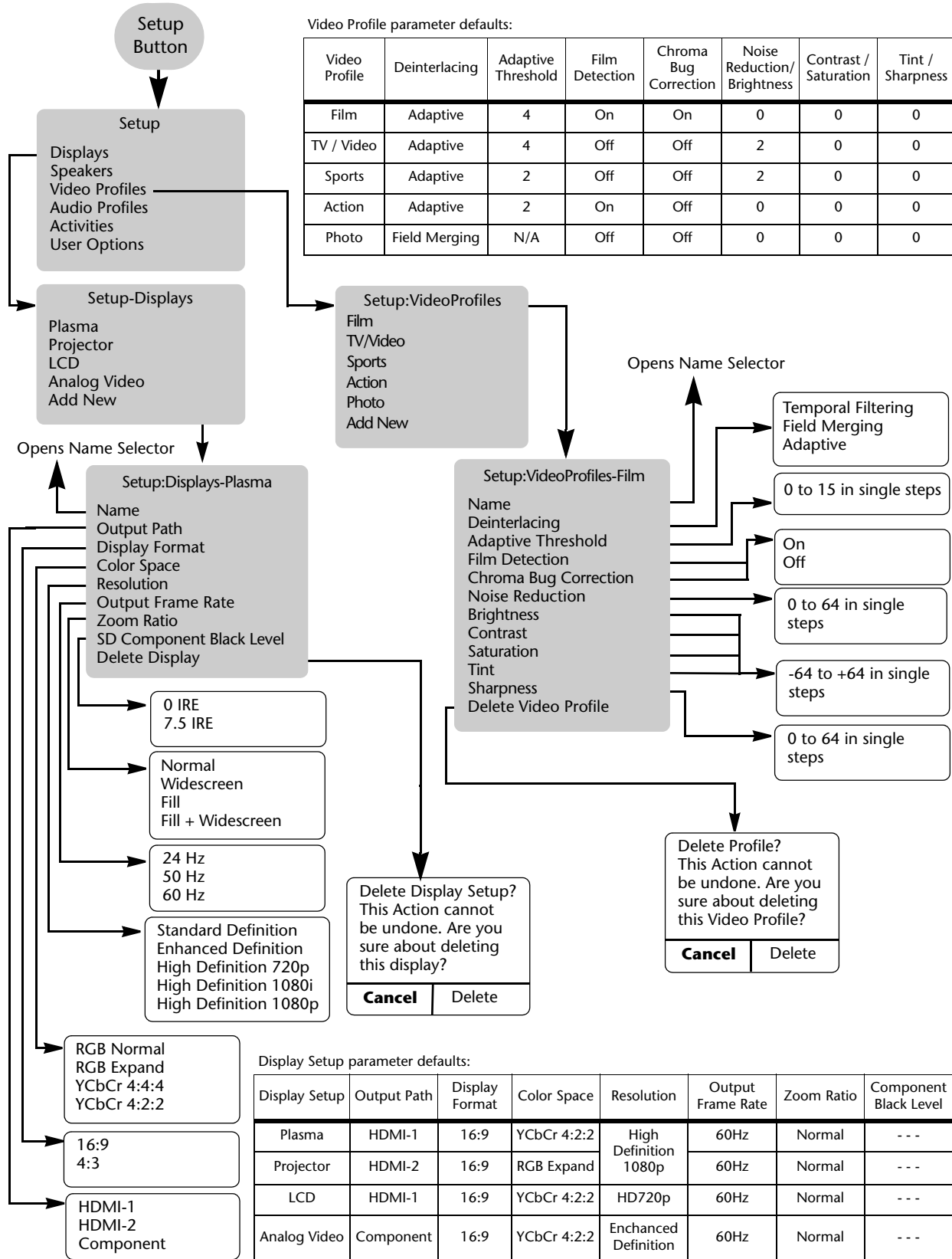

A-8

Speaker Setup Menu Tree

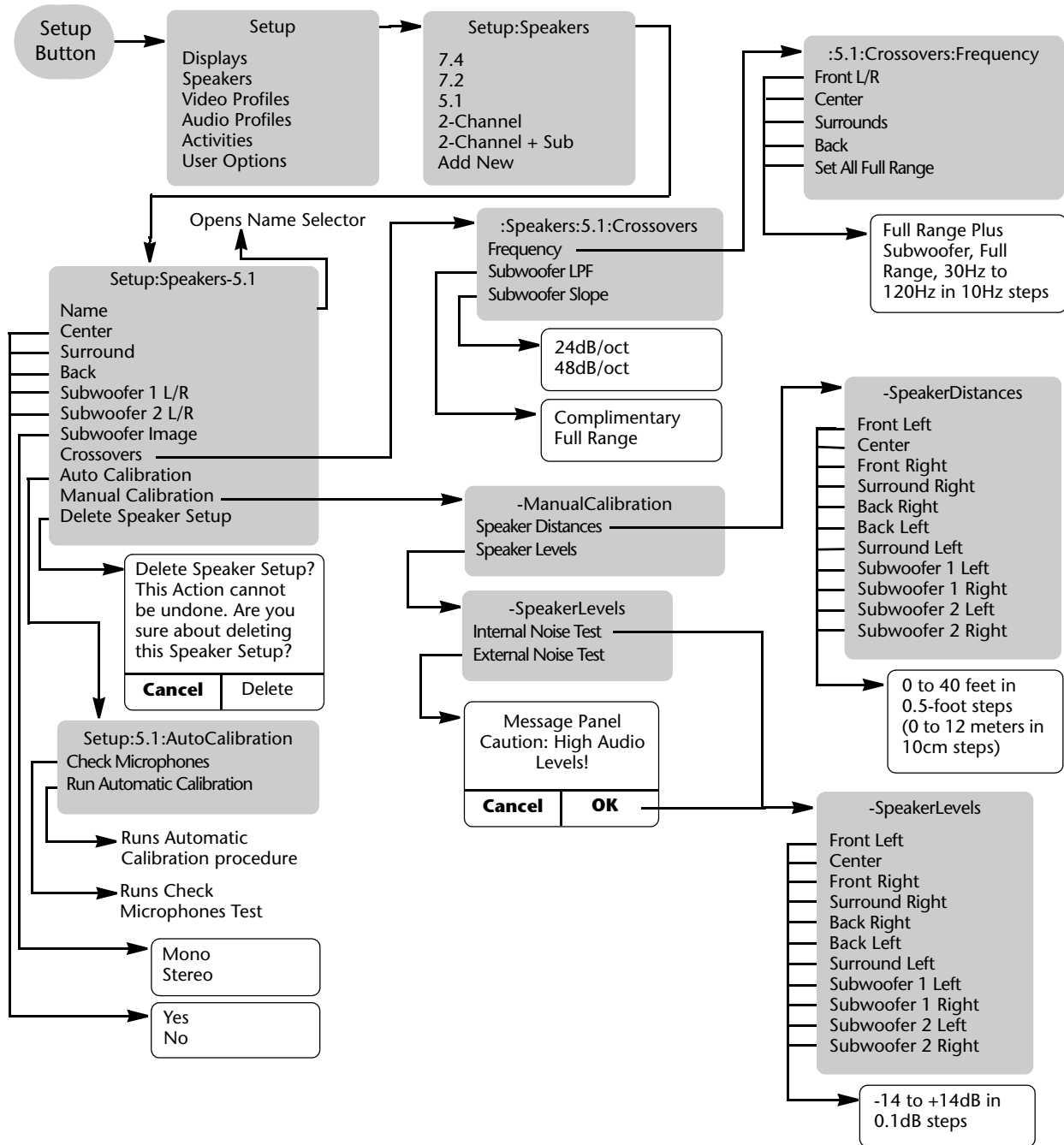

A-9

Speaker Setup parameter defaults:

Speaker Setup	Center	Surround	Back	Subwoofer 1	Subwoofer 2	Subwoofer Image	Crossover	Subwoofer LPF	Subwoofer Slope
7.4	Yes	Yes	Yes	Yes	Yes	Stereo	80Hz	Complementary	24dB/Oct
7.2	Yes	Yes	Yes	Yes	No	Stereo	80Hz	Complementary	24dB/Oct
5.1	Yes	Yes	No	Yes	No	Mono	80Hz	Complementary	24dB/Oct
2-Channel	No	No	No	No	No	No	Full Range	Complementary	24dB/Oct
2-Channel + Subwoofer	No	No	No	Yes	No	Stereo	Full Range + Subwoofer	Complementary	24dB/Oct

Audio Profile Setup & Activity Setup Menu Trees

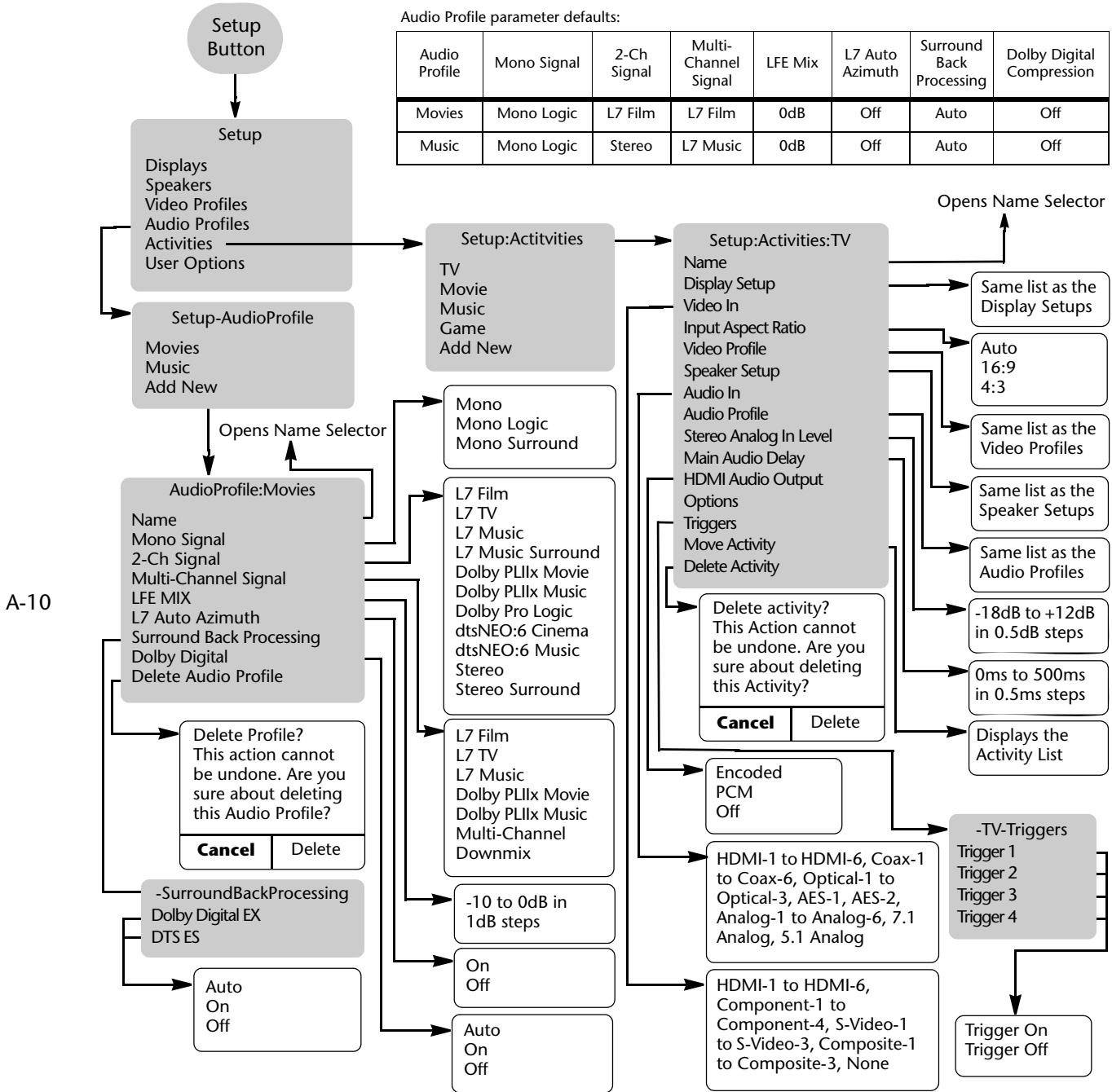

A-10

User Options Setup Menu Tree

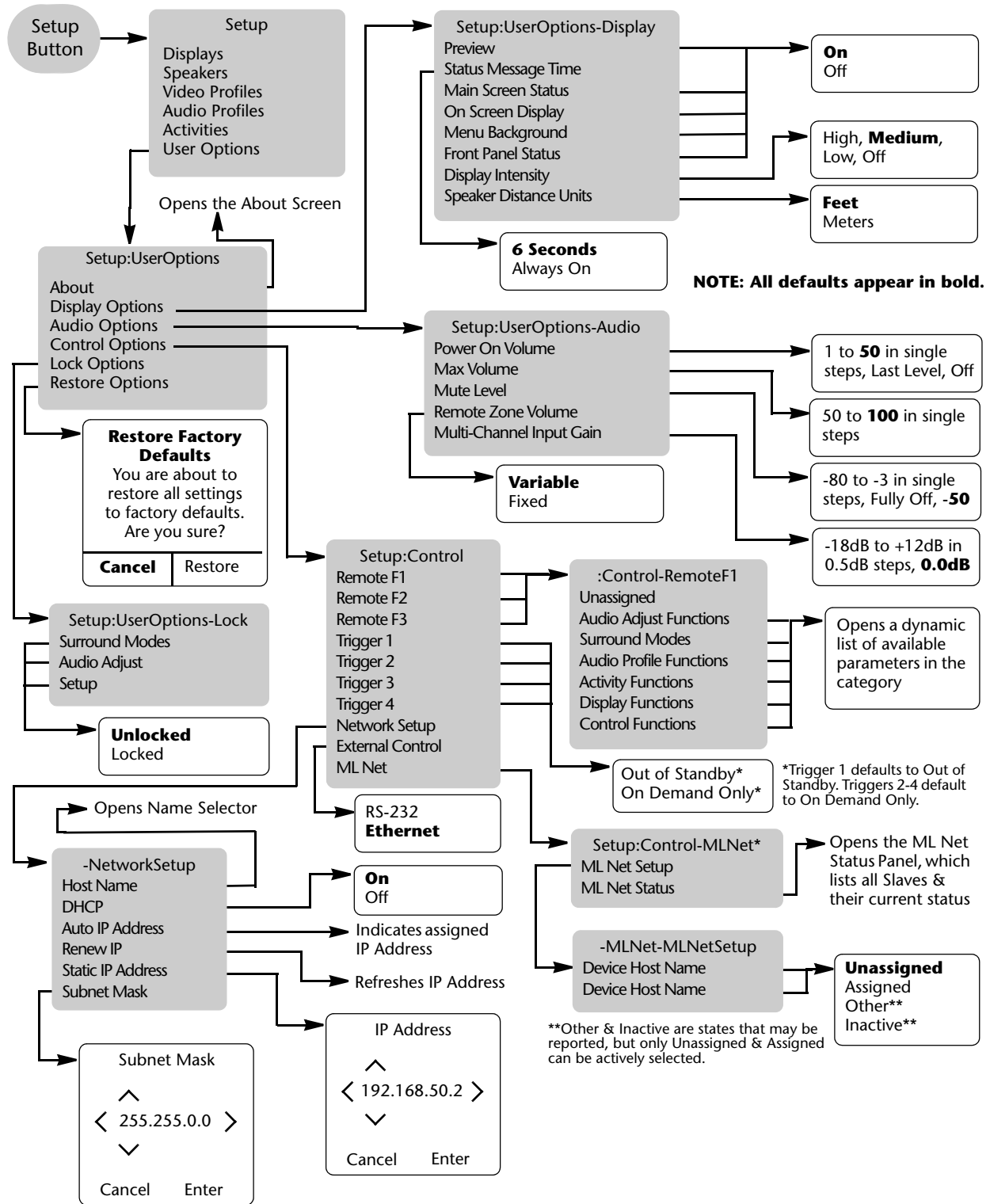

Understanding Room Correction

The N°502's Room Correction calibration is a powerful tool for optimizing the sound of your home theater system. We've included this section to provide a little background information explaining why correcting the room is so important for optimal sound quality.

Sound Wave Behavior

The listening environment greatly impacts both the way that you hear sound and the actual sound wave behavior. Outdoors, in the "open air", sound typically travels in straight lines, as there is little to obstruct the sound. However, a room has walls, a floor, and a ceiling, as well as furniture, door openings, windows, and people – all of which reflect the sound waves and create resonances within the room.

A reflected sound wave, or **reflection**, means that a sound wave bounces, or "reflects", from any object only once.

Resonance is the phenomena of multiple reflections at a specific wavelength. All rooms have resonances because sound waves always reflect from the hard surfaces – the walls, ceiling, and floor – of the room.

Sound Waves in a Room

In a typical listening room, you hear only a small amount of the sound directly from the speakers. Most of the sound you hear is reflected off of the walls, floor, and ceiling, in addition to reflections from the furniture, windows, door openings, and people present in the room.

A-12

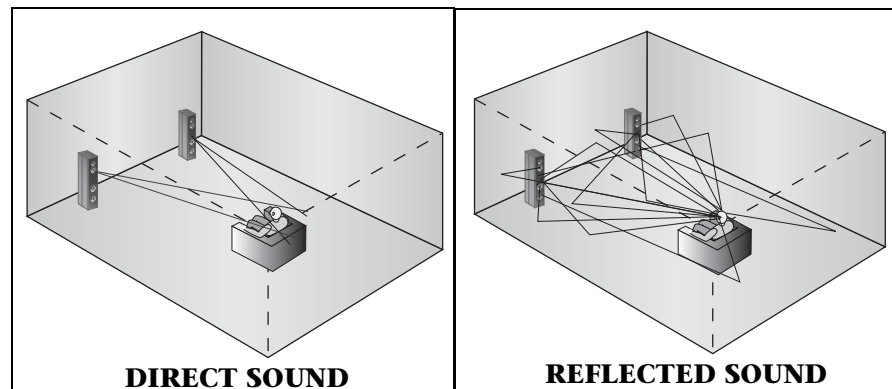

To put it simply, think of sound waves as moving objects. The wavelength of audible sound can be as long 54 feet (20Hz) or as short as 0.667 inches (20kHz). A good general principle to remember is that if the wavelength is longer than the size of the object, the wave will pass around the object as if it wasn't there. If the wavelength is shorter, strong reflections will occur.

For example, the wavelength of 100Hz is 11 feet, so it will pass around any person standing in a room. However, the wavelength of 1kHz is only 1.1 feet, so it will bounce, or reflect, off of almost everything solid – people, walls, furniture – in its path. In short, what this means is that while the 1kHz sound wave has lots of scattered reflections within the room, the 100Hz sound wave will actually resonate more because its wavelength is closer to the size of the room.

The lower frequencies tend to behave in predictable ways because the wavelengths are larger than the typical objects in a room. The mid and high frequencies generally behave differently from room to room because the foot-by-foot and inch-by-inch details differ dramatically from room to room. For example, no two rooms have the same placement of chairs, tables, lampshades, bookshelves, or people.

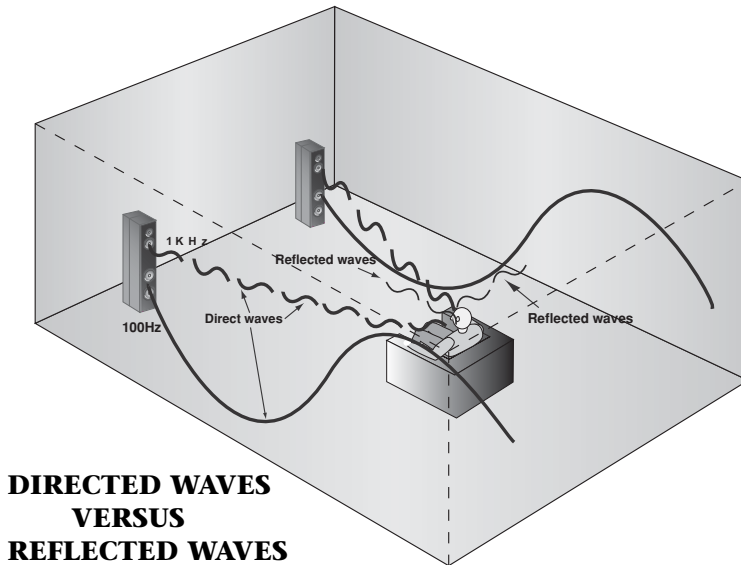

A-13

The strength of each reflection, and the end effect of the resonance, depends upon how the wavelength of the sound compares to the size and shape of the reflecting object. A small wavelength will have strong reflections from a large object, while a large wavelength will pass around a small object with very little reflection. The surface of the reflecting object can also have a strong effect on the reflections. For example, a smooth surface, like a cabinet face, will reflect very differently from a sculpture that has many different edges to scatter reflections. A good visual example of this effect is the way light reflects from a faceted diamond, which scatters the light from its many surfaces, versus how light reflects from a mirror, where the light bounces back in the same path.

The strength of the sound wave reflections can also be affected by the transmission properties of the reflector. For example, depending upon its size and stiffness, a wall may have its own resonant frequency. This can happen when a sound wave of sufficient amplitude hits the wall and causes it to resonate.

Parallel walls can create very strong reflections because the same wavelength bounces between them multiple times. The multiple copies, or reflections, of the same waveform are “added together” when they reach the listener, but the phenomenon does not necessarily produce louder sound. The relative timing between the multiple copies can produce phase shifts, meaning that there may be delays in how long it takes some of the reflections to reach the listener. These delays mean that the phase of the waveform will not match exactly and hence some reflections may actually subtract instead of add to the overall sound level. The

end result of this effect is that you hear an extremely complicated sum that cannot be easily characterized, but that contributes to the resonances that create the overall “room sound”.

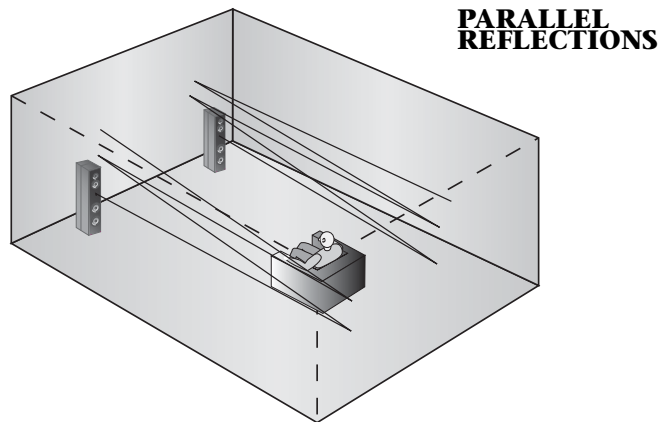

How Speakers Compensate

Good speaker designers know that there are inevitable differences from one room to another that they cannot control. So they try to develop speaker systems that will take best advantage of the known features in any room. For example, a typical cone driver does not radiate all frequencies evenly in all directions. With a floor-standing speaker, designers know how far above the floor each driver in the speaker will be and they take that height into consideration.

A-14

But no matter how good the speaker design is, the designer is still forced to make assumptions on how the typical home theater is set up and where the speakers will be placed; and it's entirely possible, perhaps even probable, that your home theater will vary greatly from the designer's vision of the typical room.

Therefore, for best results, avoid setting up your home theater room in a manner that creates problems that the speaker designer couldn't anticipate. Here are some tips for arranging your listening room for optimal sound enjoyment:

- If the room is still under construction, try to avoid building large enclaves or rectangular cavities such as foyers, bay windows, stairway entrances, and so on. Such spaces resonate specific frequencies that can greatly affect the sound quality within the room.
- Try not to place speakers in cabinets or build them into walls unless the manufacturer has specified them for such applications.
- Seats should be positioned away from walls and corners. Seating positions too close to one or more walls are subject to bass increases.
- Speakers designed to be freestanding should be used that way; likewise, those designed to be set against a wall or in a corner should be used that way. Every close boundary wall provides a boost in the

bass, so a speaker placed inappropriately will produce either insufficient or excessive bass.

This last point is very important. In most speaker designs, high-frequency sound is directional, while low-frequency sound is omnidirectional. If you've ever stood behind a speaker, this phenomenon is quickly apparent as you'll hear more bass than anything else. High frequencies are usually projected in front of the speakers, while the bass, or low frequencies, radiate in all directions.

So a speaker set in a corner will reflect the bass from both walls, while the treble, or high frequencies, are not reflected from the corner walls at all. Some speakers are designed to be placed in a corner and are hence designed to accommodate for the expected wall reflections. If one of these speakers is then placed freestanding away from the wall, the bass will not be adequate because it will not have the corner reflections to "boost" the bass sound.

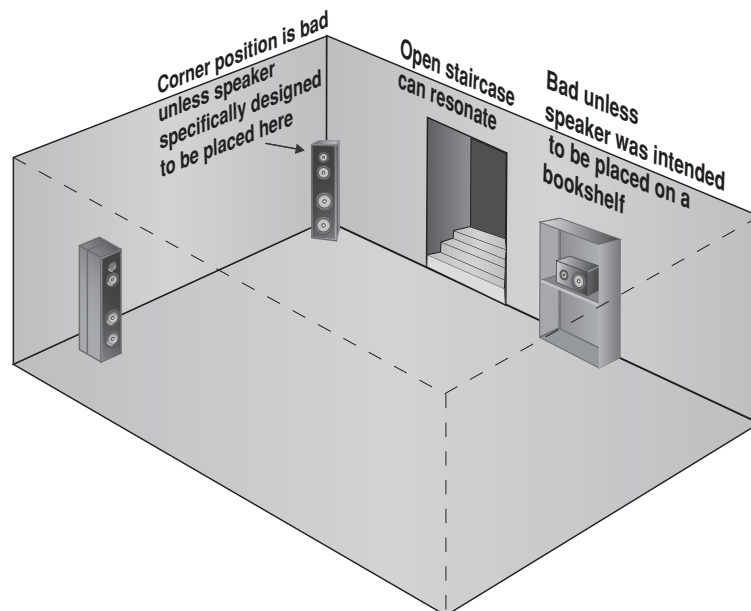

A-15

Room Modes

Room modes are resonances that occur when sound wave frequencies reinforce each other as they reflect back and forth between the hard boundaries – the walls, ceiling, and floor – of the room. The size and shape of the room determines which specific frequencies resonate.

A typical room exhibits many room modes. The resulting "sound" of a room is the addition of all the room's modes. Since not all room modes have a positive effect, the room "sound" tends to be complicated. Other factors, such as wall stiffness or the position of furniture in the room, can also have an effect on the room's resonances. At higher frequencies, these effects become less predictable and can change as people move around the room. However, at low frequencies, the modes are predictably consistent due to their long wavelengths, which means that low-frequency mode problems can be mitigated.

How Room Modes Affect the Listener

Room modes affect the frequency response you hear in several ways. The most pronounced effect of room modes is to make certain frequencies too loud. But the most difficult to solve is the tendency of some resonances to linger in the room after the speaker has stopped vibrating. A very strong resonance can linger as long as half a second and in the worst cases, the sound will also have a distinct pitch.

These lingering resonances are not always noticed by listeners because the frequencies are usually too low to be discernible as a detail unless the listener specifically listens for them. But they do present a serious problem because the lingering sound often obscures the following details of the music or soundtrack. For example, the lingering sound from a kick drum could mask the details of the following vocal passage. Subjectively, you might feel as if you were listening to the music through a layer of gauze. You might try to fix things by adjusting the overall volume or by tweaking your audio controls. However, none of these fixes can provide satisfactory results as each can cause detail loss in other areas.

For example, turning down the bass sufficiently to solve the problem with the kick drum requires all of the bass frequencies to be turned down, which could leave the rest of the score with too little bass.

Correcting Room Modes

The too-slow decay of a resonance mode can be corrected only by applying the proper filter. The severity of a resonance mode is defined by its “Q” value, or Quality Factor. The higher the Q of a resonance, the bigger its amplitude and the slower its decay. Proper treatment of a resonance requires a filter with not only the correct frequency and depth, but also the correct Q.

The Room EQ calibration of the N^o502 identifies room resonances and measures both their Q and frequency in a highly precise manner. Using this information, the calibration then applies the proper parametric filters to neutralize these resonances.

Surround Sound Issues

Surround sound is a key component of modern multimedia presentations. An action movie DVD may have great video, but the moving image of an explosion offers little thrill to the viewer without an accompanying BOOM! A tire-screeching vehicle entering the field of view from the left is more effective if the accompanying audio also comes from the left. The surround sound system is what makes it all work; hence, properly setting up the surround sound system is essential. In most installations, the seating positions pose a bigger problem than the system setup.

The two key adjustments for each speaker are timing and level. The subtle differences in timing of the sound coming out of each of several speakers is what gives you, the listener, a sense of direction. These subtle timing differences can be as short as a few milliseconds. If you are too close to one speaker in the system, many of the audio effects will seem to come from only that direction because the sound from the speaker arrives at your ears too early. Since sound travels a bit faster than 1,100 feet per second, each foot of travel takes just under a millisecond. So if one speaker is 5 feet too close to you, its sound will arrive at your ears approximately 5 milliseconds too early.

The surround processor distance settings allow the surround sound system to delay the sound from each speaker just enough to realign them all to each other. Levels must also be balanced because a speaker positioned too close to you will be too loud compared to the other speakers.

Perfect settings for level and distance apply to only one position in the room. For example, if one set is 8 feet from every speaker in the room, no other location in the room will also be exactly 8 feet from them all. A seat to the left of that first one might be 3 feet closer to the left side speaker, and the same amount further away from the right side speaker. No single set of distances will fit both seat positions. Fortunately, our perception will tolerate some deviation from “perfect” level and distance settings.

In the figure on the following page, the distance value for the side speakers is set to a location about midway between the two seats, giving an error of only 1.5 feet for both side speakers for both seats.

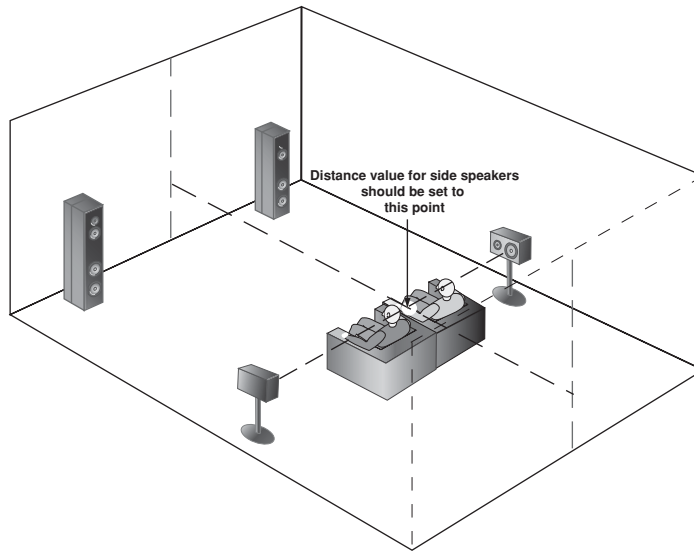

When a room has multiple viewing positions, the distance and level settings will be more accurate if all of those seats are clustered together as closely as possible.

If a favorite listening chair must be located in a remote corner of the room, the listeners will have to choose whether to accommodate the remote seat or to ignore it. No set of values will work perfectly for everyone if one or more seats are too far away from the "average" position. Any compromise to accommodate remote seats will degrade the audio for everyone.

A-18

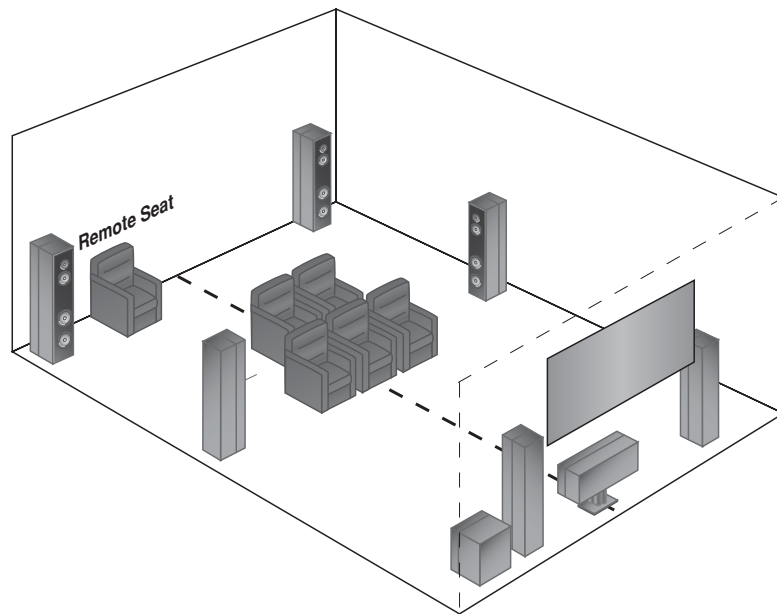

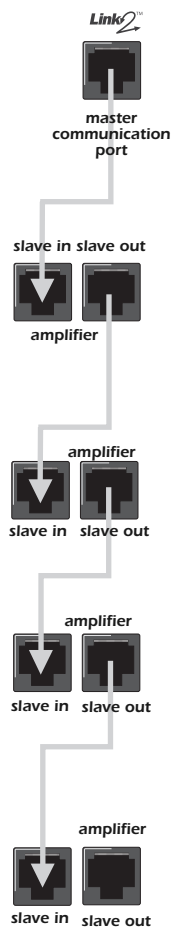

Link2

The main purpose of Link2 is to allow a single “master” device to control specific functions of other Link2-capable Mark Levinson products.

In order to use Link2, the following conditions must be met:

- Link2 support is only available for the Mark Levinson N°502 Media Console and the N°400-series Power Amplifiers.
- All products must have Link2 communication ports.

Refer to the product documentation of each Mark Levinson product to verify compatibility and cabling requirements.

To use Link2, all devices are daisy-chained together using Cat. 5 Ethernet cables, as demonstrated in the figure on the left. Each “chain” can have only one “Master” device; all other devices in the chain become “Slaves”. Slave devices receive and respond to the commands of the Master device.

The Link2 protocol can support a maximum of one Master and eight Slaves in a chain. The N°502 Media Console can only be used as a Master device. The power amplifiers must be Slave devices.

Ensure that all components are powered Off before connecting the Link2 ports.

Once connected, power on the linked components **one at a time** to ensure proper functioning of the Link2 controls. The N°502 Media Console **must** be powered on first.

A-19

Allow each component to complete the initialization sequence before proceeding to the next component. Once all components are powered on, verify that the front panel Standby LEDs on the linked components are blinking in unison.

The N°502 can perform the following Link2 functions:

- **Synchronized LEDs** – the Standby LEDs of the N°502 and all linked amplifiers should blink in unison.
- **Standby Link** – the state of the N°502 Standby mode is replicated by all linked amplifiers. When the N°502 is taken out of Standby mode, the amplifiers should also come out of Standby mode. Likewise, when the N°502 is put into Standby mode, the amplifiers should also go into Standby mode.
- **Fault Condition Reporting** – if a linked power amplifier experiences a fault condition, it’s reported on the N°502. If this occurs, the power amplifier number and the fault condition code are displayed. The power amplifier number refers to its position in the chain. For example, AMP1 refers to the first amplifier in the chain. Refer to the product manual of the amplifier for a description of the fault condition code.

Saving the N°502 Configuration

The N°502 Media Console has the ability to save your custom configurations to a computer via the Ethernet port. The N°502 uses an Internal Web page to interface with the computer. Use these instructions to download a copy of the N°502 configuration to a computer, or to reload a previously-saved configuration.

Materials Required:

- N°502 Media Console
- Two twisted-pair network cables or a network crossover cable
- PC-compatible computer with 100baseT network card
- 100baseT router (must be DHCP active)

Computer Requirements:

- Windows® 2000 Pro or Windows® XP
- Web browser (Microsoft® Internet Explorer 6.0 or higher preferred)

A-20

Cabling

The N°502 can be connected to the computer in two ways: through a router and directly to the computer. This section describes both methods.

While connecting the cables, ensure that both the computer and the N°502 are powered down.

To Connect Using a Router:

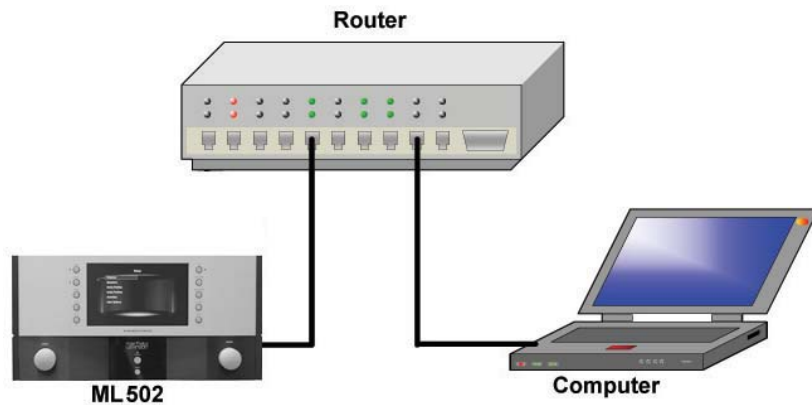

1. Connect a network cable between the Ethernet port (RJ45 connector) on the rear panel of the N°502 and the router.
2. Attach the second network cable between the router and the Ethernet port of the computer.

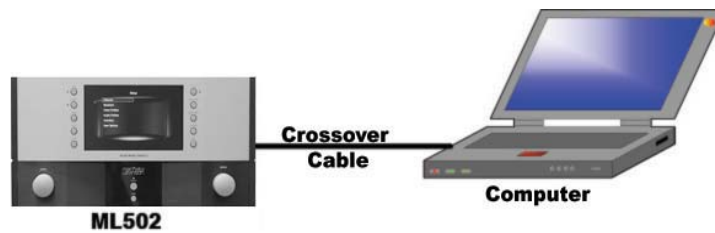
To Connect Without a Router:

To connect the N°502 directly to the computer, you must use a **network crossover cable**. A crossover cable is different from a standard network cable and is designed specifically for connecting network access ports directly together without the need for a hub, router, or switch.

Connect the crossover cable between the Ethernet port (RJ45 connector) on the rear panel of the N°502 and the Ethernet port of the computer.

Setting Up the N°502

1. Power up the N°502 Media Console.
2. Take the N°502 out of Standby mode by pressing the Standby button on the front panel.
3. Press the Setup button.
4. Select User Options from the Setup menu and press Enter.
5. Select Control Options and press Enter.
6. Select Network Setup and press Enter.
7. Assign the Network Setup parameters as follows:
 - DHCP: Off
 - Static IP address: 192.168.50.2
 - Subnet address: 255.255.0.0

A-21

Note

For more detailed information about this menu, refer to the “Network Setup” description in the “Control Options” section found in *Chapter 3: Customizing the N°502*.

8. Press the Setup button to close the menu.
9. Power cycle the N°502.

Note

In order to see the N°502, the computer must have the Internet Options setup for a LAN (Local-Area Network) connection when using a router. If not using a router, then ensure that the LAN network option is NOT selected on the computer’s Internet Options setup.

Managing the N°502 System Configurations

1. On the computer, open an Internet Explorer window.
2. In the address line, enter “http://192.168.50.2” and press Enter.

This is the Static IP address of the N°502, as set up in Step 7 of the “Setting Up the N°502” section just completed.

Note

An active proxy server may interfere with the configuration download. To ensure proper download of the N°502 configuration, turn off the proxy server while performing the procedure.

3. The N°502 Internal Web page should now be displayed.

There are three pages, shown as tabs across the top of the screen. The Home tab is in red text to indicate that it is the current page.

4. Click the Manage System Configurations tab. The tab turns to red text as the page opens.
5. There are three buttons available on the Manage System Configurations page:

- **Save Configuration** – saves the N°502 configuration to the hard drive of the computer.
- **Send Configuration** – takes a previously saved configuration from the computer and loads it onto the N°502. This downloaded configuration overwrites any existing configuration settings on the N°502. See the “Send Configuration” procedure following this one for further details.
- **Restore Options** – restores the factory configuration settings onto the N°502, erasing all existing configuration settings.

6. To:

- save the configuration from the N°502 to the computer, continue to Step 7.
- send a configuration from the computer to the N°502, skip ahead to Step 13.
- restore the factory default settings, skip ahead to Step 18.

Save Configuration

7. Click the Save Configuration button to save the current N°502 configuration to the hard drive of the computer. The browser displays a new page.
8. Right-click on “Download” to save the configuration as directed by the new page. This action displays the Windows “Save Target As...” dialog box.
9. Navigate to the desired location and, if needed, change the file name. Be sure to leave the file name extension intact.

10. Click Save.
11. The dialog box closes when the configuration has been saved.
12. Verify that the file now exists on the hard drive of the computer.

Send Configuration

13. Click the Browse button to open a Windows Browse dialog box.
14. Navigate to the location of the previously downloaded configuration file and select the desired configuration file.

The box above the Send Configuration button should now show the file name and location path.

15. Click the Send Configuration button. A warning prompt is displayed.
16. If you want to reinstall the selected configuration, press the Send button. Otherwise, press Cancel.
17. Once the configuration is loaded, a message flashes on the N°502 front panel and main displays, acknowledging that the configuration has been sent. Then the N°502 automatically resets.

Restore Options

18. Click the Restore button. A warning prompt is displayed.
19. If you want to restore the factory defaults, click the Restore button.

A-23

Note

This command is identical to the User Options: Restore Options menu option. This is NOT a recoverable action. If the factory defaults are restored, the existing configuration in the N°502 is lost.

20. The N°502 automatically resets once the action is complete.

Numerics

5-speaker enhance 3-55

A

academy filter 3-55

activities

accessing 2-3, 2-9

delete 3-32

menu 2-12

move 3-35

preview 3-35

setup 3-32–3-35

adaptive threshold 3-26

add new 3-1

aspect ratio 3-4, 3-5, 3-6, 3-33

audio

activities setup 3-34

adjustment 2-2, 2-9

adjustment menu 2-13

adjustment recall 2-14

delete profile 3-29

HDMI output options 3-34

lock options 3-41

main audio delay 3-34

options setup 3-36

profile 2-2, 2-9

profile setup 3-28–3-31

rear panel connectors 2-4–2-7

remote zone 2-7

stereo analog in level 3-34

auto azimuth 3-29

B

balance adjustment 2-13

bass enhance 3-55

black level 3-7

brightness 3-27

C

calibration 3-11

automatic 3-7, 3-12–3-22

check microphones 3-13, 4-6

microphone inputs 2-6

room correction 3-12, 4-10

run calibration 3-16, 4-7

manual 3-22–3-24

speaker distance units 3-36

center width 3-55

chroma bug correction 3-26

color space 3-5

compare surround modes 3-56

contrast 3-27

control options 3-37

crossovers 3-10, 3-11

D

deinterlacing 3-26

delete 3-2, 3-4, 3-9, 3-25, 3-29, 3-32

detailed status panels 2-15

DHCP 3-40

dimension 3-56

display

activities setup 3-33

delete setup 3-4

display format 3-4, 4-12

display intensity 2-2, 2-5, 3-36

front panel 2-3

input aspect ratio 3-33, 4-12

on screen 3-36

preview 2-1, 2-10, 3-35

setup 3-4–3-7

setup step 1 3-3

status panels 3-36

troubleshooting 4-12

user options 3-35

Dolby 3-30, 3-31, 3-50–3-52, 3-55, 3-56, 3-57

download configuration 3-43

downmix surround mode 3-53, 3-57, 3-58

DTS 3-30, 3-52

E

effect level 3-56
 enter button 2-2, 2-9
 error messages 3-47, 4-6
 ethernet 2-6, 3-39, 3-41
 external control 3-41
 ethernet port 2-6
 Link2 port 2-6
 ML Net 3-43
 network setup 3-39
 RS-232 2-6
 trigger outputs 2-6
 triggers 3-35, 3-41, 3-42
 external noise test 3-24

F

factory default settings 3-41, 4-15
 fader adjustment 2-13
 field merging 3-26
 film detection 3-26
 frequency, crossovers 3-10
 front panel
 button descriptions 2-1–2-3
 display 2-3
 display intensity 2-2, 2-5, 3-36
 overview 2-1
 remote control comparison 2-11
 status panels 3-36
 user options 3-35
 front steering 3-56
 function buttons 2-9, 4-8

H

HDCP 3-4
 HDMI 2-4, 2-5, 3-34
 host name 3-39

I

inputs 4-8, 4-9
 activities setup 3-33, 3-34
 aspect ratio 3-33
 multi-channel input gain 3-37
 rear panel connectors 2-4–2-7
 installation considerations 1-3
 interlaced video 3-26
 internal noise test 3-23
 internal web pages 3-38, 3-43
 IP Address 3-40
 IR input 2-6

L

letterboxing 3-5, 4-13
 LFE mix 3-29
 light button 2-9
 Link2 2-6, 3-46
 lock options 3-41
 Logic 7 3-29, 3-48–3-50, 3-55, 3-56, 3-57, 3-58

M

main audio delay 3-34
 master level 3-57
 max volume 3-37
 menu
 audio adjustments 2-13
 background 3-36
 button 2-2, 2-9
 overview 2-12
 path 2-12
 setup menu 3-1
 surround mode adjustments 2-14
 microphones 2-6, 3-13, 4-6
 ML Net 2-6, 3-43–3-47
 monitor output 2-5, 3-36
 mono 3-10
 mono modes 3-53, 3-54, 3-55, 3-56, 3-58
 multi-channel 3-52
 multi-channel input gain 3-37
 multi-channel surround modes 3-56
 mute 2-2, 2-10, 3-37

N

name
 add new 3-1
 modify 3-2, 3-4, 3-9, 3-25, 3-28, 4-9
 selector 3-59
 navigation buttons 2-8
 network setup 2-6, 3-38, 3-39–3-41, 3-43
 №502
 about 1-1, 3-35
 configuration 3-43
 first-time operation 1-5
 front panel 2-1
 front panel display 2-3
 initial power-up 1-5
 maintenance 4-16
 options 1-2
 rear panel 2-4
 registration 1-2
 remote control 2-8
 setup step 1 3-3

- setup step 2 3-7
- unpacking 1-5
- noise reduction 3-27

O

- offset adjustments 2-13
- on demand only 3-42
- on screen display 3-36
- out of standby 3-42
- output frame rate 3-6
- output path 3-4
- outputs
 - analog audio 2-6
 - component video 2-5
 - HDMI 2-5
 - monitor 2-5, 3-36
 - remote zone 2-7

P

- panorama 3-57
- pillarboxing 3-5, 4-13
- power 4-9
 - AC input 2-7
 - initial power-up 1-5
 - operating states 1-4
 - power button 2-3
 - power on volume 3-37
 - power requirements 1-4
 - standby button 2-3, 2-10
- preview 2-1, 2-10, 3-35
- product registration 1-2
- progressive video 3-26

Q

- quick status panels 2-15

R

- rear delay offset 3-57
- rear panel connectors 2-4-2-7
- recall audio adjustments 2-14
- re-equalizer 3-57
- registration 1-2
- remote control
 - button descriptions 2-8-2-10
 - front panel comparison 2-11
 - function buttons 2-9, 3-38, 4-8
 - light 2-9
 - overview 2-8
 - replacing the batteries 1-6

- remote zone audio
 - accessing 2-1, 2-10
 - menu 2-12
 - rear panel connectors 2-7
 - volume 3-37
- resolution 3-6
- restoring factory defaults 3-41, 4-15
- room correction 2-13, 3-12, 4-10
- RS-232 2-6, 3-41

S

- saturation 3-27
- SD component black level 3-7
- setup menu
 - accessing 2-2, 2-9, 2-12
 - activities 3-32-3-35
 - add new 3-1
 - audio profiles 3-28-3-31
 - delete 3-2
 - displays 3-4-3-7
 - lock options 3-41
 - name 3-2
 - name selector 3-59
 - speakers 3-8-3-24
 - step 1 3-3
 - step 2 3-7
 - user options 3-35-3-41
 - video profiles 3-25-3-28
- sharpness 3-28
- sound stage 3-57
- speaker setup 3-8-3-24
 - activities setup 3-33
 - automatic calibration 3-12-3-22
 - crossovers 3-10
 - delete 3-9
 - distance units 3-36
 - distances 3-22
 - levels 3-23
 - manual calibration 3-22-3-24
 - setup step 2 3-7
 - subwoofers 3-10, 3-11
- standby 1-4, 2-3
- status panels 2-15, 3-36
- stereo 3-10, 3-34, 3-53
- subnet mask 3-40
- subwoofer image 3-10
- surround
 - button 2-2, 2-9
 - Dolby modes 3-30, 3-31, 3-50-3-52
 - DTS modes 3-30, 3-52
 - hide all 3-54
 - lock options 3-41

- Logic 7 modes 3-29, 3-48–3-50
- mode adjustment 2-14
- mode descriptions 3-48
- mode parameter descriptions 3-55–3-59
- mode selection 3-29, 3-47
- show all 3-54
- surround back processing 3-30
- surround delay 3-57
- surround mix 3-58
- surround roll-off 3-58
- using modes 3-47–3-54

T

- temporal filtering 3-26
- tint 3-27
- triggers 2-6, 3-35, 3-41, 3-42
- troubleshooting 4-1–4-5
 - display formats 4-12–4-14
 - error messages 4-8–4-10

U

- user options 3-35–3-41

I-4

V

- ventilation 1-3
- video
 - activities setup 3-33
 - delete profile 3-25
 - preview 2-1, 2-10, 3-35
 - profile 2-2, 2-9
 - profile setup 3-25–3-28
 - rear panel connectors 2-4–2-7
- vocal enhance 3-58
- volume 2-2, 2-3, 2-10, 3-37, 4-8

W

- web pages, internal 3-38, 3-43

Z

- zone button 2-1, 2-10
- zoom ratio 3-5, 3-6

mark 
LEVINSON.®